



GUIDEBOOK OF REED BUSINESS

GUIDEBOOK OF REED BUSINESS

The publication is supported by the EU through the European Regional Development Fund



Project partners, main coordinators and their E-mail addresses:

Turun University of Applied Sciences, Anne Hemmi, anne.hemmi@turkuamk.fi

Centre for Economic Development, Transport and the Environment of Finland, Iiro Ikonen, iiro.ikonen@ely-keskus.fi

Livia ammatikoulu, Veli-Matti Jalli, veli-matti.jalli@livia.fi

Tallinn University of Technology, Ülo Kask, ykask@staff.ttu.ee

Estonian University of Life Sciences, Jaan Miljan, jaan.miljan@emu.ee

Riga Technical University, Aigars Laizans, aigars.laizans@rtu.lv

Vides Projekti



CENTRAL BALTIC
INTERREG IV A
PROGRAMME
2007-2013



EUROPEAN UNION
EUROPEAN REGIONAL DEVELOPMENT FUND
INVESTING IN YOUR FUTURE

The publication reflects the authors' views and the Managing Authority cannot be held liable for the information published by the project partners (Inetrreg IV-A programme, EU investing)

Cover photos: Reed bed at Loode tammik (Photo: Ü. Kask), (4 smaller photos: M. Miljan)

Editor: Tallinn University of Technology, Ülo Kask

Compiler: Estonian University of Life Sciences, Jaan Miljan

Layout: Sirje Keskküla

Printing: Salibar OÜ

The publication is available also on internet <http://www.cofreen.eu>

Reed Strategy project is implementing Interreg IV A – programme between Finland, Estonia and Latvia.

ISBN 978-9949-484-91-1

| | |
|---|----|
| <i>Content</i> | 5 |
| <i>Foreword</i> | |
| Anne Hemmi , Turku University of Applied Sciences | 6 |
| 1. Common Reed | |
| Johanna Myllyniemi, Mari Virtanen , Turku University of Applied Sciences | 9 |
| 2. About the Use and Protection of Reed Beds | |
| Kaja Lotman , the Environmental Board of Estonia, Aleksei Lotman , the Estonian Fund of Nature | 16 |
| 3. Reed as a Building Material | |
| 3.1. Reed Harvesting for Construction Purposes, Reed's Quality and Harvesting Technology | |
| Jaan Miljan , Estonian University of Life Sciences, Department of Rural Building | 21 |
| 3.2. Determination of Thermal Conductivity of Reed in Estonian University of Life Sciences | |
| Martti-Jaan Miljan, Jaan Miljan , Estonian University of Life Sciences, Department of Rural Building | 26 |
| 3.3. Determination of Thermal Conductivity of Reed in TRC of Finland | |
| Rauli Lautkankare , Turku University of Applied Sciences | 28 |
| 3.4. Thermal Transmittance of Wall Fragments Insulated with Reed | |
| Martti-Jaan Miljan, Jaan Miljan , Estonian University of Life Sciences, Department of Rural Building | 30 |
| 3.5. Construction of Test House with Reed Insulated Enclosures, Materials and Time Used during the Construction | |
| Matis Miljan, Jaan Miljan, Martti-Jaan Miljan , Estonian University of Life Sciences, Department of Rural Building | 33 |
| 3.6. Thermal Transmittance of Enclosures of the Test House | |
| Martti-Jaan Miljan, Jaan Miljan , Estonian University of Life Sciences, Department of Rural Building | 33 |

| | |
|--|----|
| 3.7. <i>The Mold Test</i> | |
| Rauli Lautkankare, Turku University of Applied Sciences | 42 |
| 3.8. <i>The Fire Test of Thatched Roofs</i> | |
| Rauli Lautkankare, Turku University of Applied Sciences | 46 |
| 3.9. <i>Thatched Roof as an Insulation Layer</i> | |
| Karel Lilleste, Meeli Kams, Estonian University of Life Sciences, Department of Rural Building | 50 |
| 3.10. <i>Light Clay-reed Blocks</i> | |
| Kristina Akermann, Estonian University of Life Sciences, Department of Rural Building | 56 |
| 4. <i>Reed as a Renewable Energy Source, Equipment and Technologies for Using Reed in Energy Industry</i> | |
| Ülo Kask, Livia Kask, Tallinn University of Technology | 57 |
| 5. <i>Reed Supply Chains, Mowing Equipment and Technologies, Logistics, Environmental Impact from Reed Supply Chain, Supply Risks</i> | |
| Ülo Kask, Livia Kask, Tallinn University of Technology | 77 |
| 6. <i>Biogas Production from Reed</i> | |
| Veli-Matti Jalli, Livia AK, Ülo Kask, Tallinn University of Technology, Aigars Laizans, Riga Technical University | 88 |
| 7. <i>Reed as Handicraft Material</i> | |
| Satu Paananen, Turku University of Applied Sciences | 96 |
| 8. <i>Business Models and Socio-economic Effects of Reed Business</i> | |
| Aigars Laizans, Riga Technical University | 99 |

Foreword

Expanding reed beds along the Northern Baltic Sea pose a challenge to both coastal residence and natural biodiversity. When overgrowing recreational areas along the coastal areas, reeds trouble surface water quality, boating and swimming and thus, bring forth the need to get rid of reed where it is concerned as a nuisance. On the other hand, reed is known to have a huge potential in many aspects: it can serve as a non-crop energy species, and the material is excellent in many ways construction.

A joint three-year Cofreen -project was established to promote this goal. It was funded by the EU's Central Baltic INTERREG IVA 2001-2013 Programme, and was led by the Turku University of Applied Sciences. Consortium consisted of 7 partners from Finland, Estonia and Latvia. Cofreen relied on the existing knowledge of the previous reed projects and brought that together with the added new perspectives to utilization and reed business possibilities.

To enable substantial reed utilization, first we need to recognize the obstacles in reed harvesting and integrated land management. Secondly, logistics and end users have to be identified and optimized to achieve a successful production chain. What is finally left under the line holds often other than monetary values in sound accordance with economical values.

This Guidebook offers visions to wide range reed utilization possibilities and preconditions. Reed issues have been our long-term interest and solutions have been developed to achieve multiple benefits for the region, environment and markets. Increasing awareness of the wide range potential of reed biomass opens a chance to concrete business opportunities. Shifting from fossil based to bio-based economy is widely acknowledged, and partner organizations in Cofreen are more than willing to promote this goal.

Turku 5.6.2013

On behalf of the Cofreen-project,

Anne Hemmi

Project Manager, Cofreen-project (EU Central Baltic INTERREG IVA 2007-2013)

1. Common Reed

Johanna Myllyniemi, Mari Virtanen, TUAS

Common reed (*Phragmites australis*) is a perennial grass with a vertical stem. Usual height for common reed is 1 to 3 meters in the Nordic, but in nutritious conditions it can reach a height of 4 meters. In some cases it has been reported to grow even up to 7 meters (Roosaluste 2007, 8). Green and sharp-fringed leaves are long and 1 to 2 centimeters wide. Reed has a vast and branching rhizome. Numerous races of reed do exist, but clones, hereditarily similar growths, can embody very variable appearances in different habitats. Common reed is often confused with club-rush (*Schoenoplectus tabernaemontani*) which is a plant belonging to sedges (Huhta 2008).

Habitats

Reed is a plant of relatively warm and temperate conditions and it prospers in abundant light. Habitats are diverse and range from low-lying lands up to relatively great heights in the mountains, as well from coastal areas of both fresh and brackish water to moist boundaries of fields and untreated coastal meadows (Roosaluste 2007, 8). Habitats also include nutritious swamps and sometimes areas that can seem relatively dry (Huhta 2008). Reed is an indicator of periodically flooded areas, but does not require continuous flooding. Reed forms dense growths in shallow water with clay bottom, but it also prospers in silt, mud and sand (Silen 2007, 6; Ikonen & Hagelberg 2008, 7).

Reed can grow at the depth of 2.5 meters, but in the event plant has to use a lot of energy to grow the photosynthetic sprout up to the surface. The water depth also affects water plants with aerial stems by the oxygen-carrying capacity: the deeper the plant grows, the more difficult it is to transport oxygen down to the roots. It has been estimated that the optimal depth varies from 0.1 to 0.8 meters. (Silen 2007, 6; Ikonen & Hagelberg 2008, 7.)

Optimal water salinity for reed is 0-15 ppt. Sulfides can also limit spreading, but on the other hand the vegetatively reproducing clones are able to flee from unprofitable contents (Weisner & Strand 2002). Reed

is an indicator for slightly acidic or neutral conditions, but never grows in heavily acidic areas. On the contrary, the species grows often in nitrogen-rich areas (Ellenberg 1992). Strong current, drought, other disturbance in the environment and competition with other species can also limit spreading of reed (Weisner & Strand 2002). The success of reed in coastal marine areas is boosted by its good tolerance towards changes in water level and coastal ice. Large size and deep roots are adaptations to these disturbances (Ellenberg 1992).

On mud base, reed beds can get as thick as 300 sprouts per square meter, but the usual amount varies between 40 and 100 (Jalas 1958). In Finland, the dry matter yield can exceed 2.0 kg/m² at its best, but elsewhere the yield can be a lot higher (Silen 2007, 7; Ikonen & Hagelberg 2008, 8).

Distribution

Common reed is one of the most widespread vascular plant species in the world existing in all continents except the Antarctic. It is estimated that there are at least 10 million hectares of reed beds in the world (Runnérus 1981), and the number is likely to be greater nowadays. For instance, in the Danube delta, reed beds cover 150 000 hectares (Björk & Granéli 1980). Finland has an estimated amount of 100 000 hectares of reed beds, for in Sweden the number is counted to be similar, and 28 940 hectares exist in Southern Finland's shore alone, which covers 1,03 percent of the coastal municipalities' area. This study about Finland's and Estonia's reed beds was made by satellite mapping in 2006 (Pitkänen 2006, 14). The area of reed beds has increased over the last decades, which results from the decreased pasturage on the coastal areas. The species has also benefited from the eutrophication of waters which has occurred during the last decades. (Väre et al. 2004). Reed seems to be vulnerable to regress in case of root damage (Karunaratne et al. 2004). Pasturage has apparently once affected the reed bed by damaging the sprouts and the roots, and thus the plant has not been able to form present-like monocultures (Väre et al. 2004).

Pitkänen has also studied reed beds in the coastal municipalities of Estonia's Väinameri sea, where reed beds were counted to cover approximately 17 000 hectares. That means 1.1 percent of the

coastal municipalities' area, including water systems (Pitkänen 2006, 47). The European common reed species has also extended its field to North America, Africa and Australia, and has replaced original local plant species, including the native reed species of North America, in many places. This has decreased the biological diversity of the nature (Väre et al. 2004). Reed often forms vast monocultures, growths of one species, and it spreads effectively to new areas (Ellenberg et al. 1992). When common reed has gained a foothold in a new habitat, it usually takes years for a reed bed to develop into a monoculture (Güsewell 2003).

Except the Nordic, in other parts of Europe reed has been strongly regressing. The phenomenon develops over the years and is called a "die-back". Eutrophication and vast utilization of shores and water systems are reasons for this but these are not the only ones, for reed survives well on the shores of eutrophic lakes or in reed refineries with high nutrient amounts. Other causes are found as well, for instance grazing, flooding, the usage of land and increased amount of salt. Usually reed beds have suffered a setback near cities and other populated areas. (Ostendorp 1989, van der Putten 1997)

Reproduction

The seed-developing inflorescence of reed is a thick panicle, about the size of a large palm. The size depends significantly on the circumstances of the habitat. Panicles are not developed in only the most unfavorable areas where reed grows as a habitat relict, such as on rocky beaches that are prone to waves; swamps, fields and edges of forests (Jalas 1958). Reed is a wind pollinating plant, just like other grasses (Valste 2005, 269). It blossoms in late summer in the Nordic, but the seeds mature in the middle of winter. Seeds that are able to germinate are not formed every year. After flowering, the stem stiffens, drops its leaves and remains sticking out of the ice. The seeds pervade in the nature with the wind, along the surface of the ice or snow, or carried by animals or humans in late winter or early spring (Paavilainen 2005, 12; Silen 2007, 6; Ikonen & Hagelberg 2008, 7). After the ice has melted away, the previous summer's dry stems remain carried by the waves and bank up on the shores, but sometimes they can also

abide until the next growing season. Seed sprouts are often found in this kind of banks (Jalas 1958), because they have no opportunities to survive in thick reed bed. The seeds need a lot of sunlight and prosper in open environments with little competition (Saltonstall 2003).

In the Nordic, reed sprouts begin their growth in April and in June the growth is fastest. During that time reed can grow up to over 10 cm per day. In July the growth ends and reed beds begin the flowering. (Silen 2007, 7; Ikonen & Hagelberg 2008, 8.) The life cycle of a reed rhizome is usually 5 to 7 years long. Reed seeds remain their germinative capacity for at least one year, and the capacity is usually 3 to 44 percent in Finland. Reed overwinters as green hibernation buds which are located in the underground storage tissue called geophyte (Ellenberg 1992).

However, sexual, seed based reproduction is scarce, and reed spreads mostly vegetatively with its strongly branching subterranean rhizome (Roosaluste 2007, 8; Weisner & Strand 2002). The roots of the rhizome are long and 1 to 3 cm thick. Normally it reaches the depth of 5 to 35 cm, but sometimes it can grow as deep as 60 to 80 cm underground (Ikonen & Hagelberg 2008, 7). In addition, reed has thin and over half meter long roots both vertically and horizontally. The rhizome covers approximately two thirds of the reeds biomass, sometimes even 80 percent (Isotalo et al. 1981). With this rhizome reed growth can expand several meters per year. Deep water can prevent the vegetative spreading (Weisner & Strand 2002). Aerial shoots can grow even at 10 meters distance from the rhizome (Ikonen and Hagelberg 2008, 7). In addition, reed takes and stores nutrients within it. These nutrients are vital for growth start in springtime and also for survival from unpredictable stress situations caused by the environment (Graneli et al., 1992).

Chemical impacts

The propagation of reed can be launched by mechanisms such as drainage, when the concentration of sulfides decreases, even though salinity would remain unchanged. Reed itself can affect especially the sulfide concentration of the top part of the sediment by oxidizing it with pressurized breathing. Reed is able to lower the concentrations of hydrogen sulfides

in the pore water of the sediment when it transports oxygen to its roots and increases the transition of the pore water into the air. If the plant is damaged, its ability to do this with the old sprouts weakens and thus the amount of disadvantageous sulfur and nitrogen compounds around the roots increases (Bart & Hartman, 2000). Stressful circumstances reduce the plant's ability to take ammonium nitrogen from the ground by weakening the energy economy of reed (Van der Putten 1997).

Plants that grow under conditions with low oxygen levels have several adaptations related to vital functions, with which water plants with aerial shoots are able to tolerate flooding. These include generally low demand of oxygen for effective metabolism of the roots and anatomical adaptations, such as differentiated aerenchyme tissue, with which the plant can transport gases from the shoots to the roots and vice versa (Armstrong 1978). It is important for them to be capable of immediately oxygenating the surroundings of the roots, because this way they avoid taking poisonous substances from the ground (Gries & Garbe, 1989). Reed's ability to transport oxygen from the shoots to its underground parts weakens when the water deepens. Eutrophication increases the reduction level of the sediment and affects especially the growing of reed beds in high depths of water. Eutrophication increases the density of stalks, weakens the stability of the skin and increments the growing opportunities for filamentous algae in the reed bed. (Schröder, 1979)

A 50-percent decomposing of reed mass lasts from a few months to a few years depending on the climate, hydrological conditions and the composition of the plant matter itself (Pokorný & Kvet 2003). In eutrophic waters the decomposing of plant mass is stimulating the activity of microbes. This can lead to a shortage of oxygen, a low oxidation-reduction potential and finally to black bottom sediment that releases methane, hydrogen sulfide and also water-diluted phosphorus in the air (Mannila 2006).

Ecology

Reed is one of the most dominant species in wetlands and coastal zones of the world. For reed is so widespread and in many places very abundant, it has a significant impact on ecosystems and organisms of

coasts and other areas. Reed beds are a significant part of the nature and they belong to the aquatic landscapes. Reed is an ecologically beneficial plant in several ways, (Huhta 2008, 5.) but on the other hand, only few grasses can compete with reed in density and spread. High and thick growths of reed reduce the quantity of light in the breeding ground and thus the possibilities of survival for other plant species. Dead reed matter forms thick litter layers which prevents other species' seeds from sprouting. Also the aggressively acting rhizome effectively limits the spreading of other plants (Roosaluste 2007, 8–9). In addition, the spreading of reed beds reduces the survival opportunities for many animal species with habitats on the shore.

Waterside vegetation, including reed, acts as a filter for the nutrients washed from the land. Thick vegetation holds nutrients and solid matter in place. Above waterline, before they end up in the water, reed bed holds back part of the matter that the water catchment contains. At the same time the plant zone suppresses swell erosion, and as a result the bottom sediment with its nutrients stays put and is not washed to the open water to increase the load of the oxygen-consuming organic matter. (Eloranta, 2005, 26–27; Kääriäinen & Rajala, 2005, 251)

For people's recreational usage reed beds have also their pros and cons. Thick reed beds hide landscapes from view, produce unpleasant odors to the shores and limit the opportunities for swimming and boating. By contrast, reed beds offer cover from the neighbor's and they can be excellent excursion destinations with their duckboards and bird-watching towers. On the common beaches reed beds are usually experienced as hindrances, apart from recreational areas with diverse birdlife. (Ikonen & Hagelberg 2008, 22) The increase of vegetation and overgrowth are partly pertained to natural development of water systems which takes place in every shore of lakes and seas. Removal of reed improves the shore's landscape and opportunities for recreational use, but it is not the only action needed to improve the water quality. The removal can also limit the chances for many animal species that need reed beds. Concerning the removal of reed, it would be the most profitable to find a balanced situation, where reed beds and mowed areas would alternate.

Reed Beds as Habitats

Various species have benefited from the increase of reed beds, and some of them have even followed reed beds. Concerning nature's biological diversity, the most important reed bed types are the mosaic-like fringes of reed beds, because the versatile structure of the reed bed ensures a diverse birdlife (Ikonen & Hagelberg, 2008, 16). The nature directive of the EU includes the dragonflies and moor fogs, inter alia, which are able to utilize puddles among reed beds (Ikonen & Hagelberg, 2008, 16), whereas bats and otters of the directive's species are able to use these puddles as shelters (Erkinaro et al. 2007, 30–31).

Reed beds provide important habitats for algae as well. On the surface of a reed stalk lives a vast group of surface algae that take their nutrients straight from the water, decreasing eutrophication and offering shelter for phytoplankton-preying and thus removing zooplankton. If the reed beds are removed, also the substrate of the algae and zooplankton's shelters disappear. In that case more nutrients are available for the phytoplankton and algae blooming increases. This can be seen even with bare eyes when the blue green alga that also belongs to phytoplankton, becomes more general. In shallow lakes, the mowing of reed can strengthen the growth of phytoplankton also because of the increased amount of light entering the water. (Eloranta 2005, 26–27; Kääriäinen & Rajala 2005, 251)

Birds

Reed beds are important habitats for various bird species. Aquatic birds use reed beds as spots for nesting, eating and resting. The increase of vast reed bed areas in the Nordic has increased habitats for reed-dependent birdlife. During the last century, many reed bed species have extended their range in the Northern Europe, and the species previously nesting in the area have strengthened their populations. On the other hand, in Middle and Southern Europe where reed beds are nowadays rare, several species marked to reed beds have remarkably regressed. At best, reed beds are sheltered nesting environments with plenty of food for many bird species. Eutrophic bays with reed beds are important areas for various fish and

insect species, so they provide nutrition for birds. The best reed bed for maintaining a diverse birdlife is volatile in height and depth and broken by water areas. If low-grown shore meadows are combined with reed beds, the value of wetland is increased substantially. (Below & Mikkola-Roos, 2007, 24)

Different bird species thrive in different reed beds. Some of these species, such as bitterns, need vast reed areas to stay for nesting, whereas for many species the mosaic-like structure of the reed bed is especially important because majority of the birds live in the edges of vegetation patterns, for instance in the interface of a reed bed and open water. Such species include great crested grebe, horned grebe and black coot that build their low, conical nests with reed stalks to the edges of a reed bed, or to a sparse one. Moreover, some species, such as western marsh harrier and rails (water hens), live in those parts of reed bed that are remarkably wet and difficult to reach. Reed buntings can also nest in dry reed beds, but the frequencies remain lower than in wet-based and broken reed beds. If there are suitable nesting islets in reed bays, also black-headed gull settles there for nesting. Bearded tit nests in the vast reed beds of sea bays. Reed beds are also a significant habitat for little grebes, gadwalls, Montagu's harriers and little crakes. Citrine wagtail nests also on the interfaces of wet meadows and reed beds, when the nest itself is often on the reed bed side. (Below & Mikkola-Roos, 2007, 24-26.)

Bays with reed beds are important spots for migratory birds as well. Thousands of birds on their way to the Northern nesting areas or returning from there for wintering in the South can gather to these bays. Principally these birds are species that also nest in reed beds, but also birds that prefer other environments for nesting stop there for eating and resting in a sheltered place. These include many warblers, willow warblers and blue throats. Reed beds also act as gathering areas during molting of feathers. In the winter, many species such as blue tits, bearded tits and reed buntings utilize the seed and insect nutrition provided by reed beds. (Below & Mikkola-Roos, 2007, 27-28) If water gets shallower and reed beds close up by the decomposing process, the birdlife is depleted and thus gets more one-sided when the most valuable bird species disappear. Bittern, western marsh harrier and dabbling ducks are the most demanding nesting spe-

cies of reed beds. Also open coastal meadows get into difficulties when reed spreads on them and their birdlife has to leave elsewhere. (Below & Mikkola-Roos, 2007, 26)

Fishes

Reed bed areas are habitats and reproduction areas for numerous fish species. Fishes eating both zooplankton and benthos find nutrition from there and many predator fishes, for instance pike, hunt among the vegetation (Kääriäinen & Rajala 2005, 251). On the coastal areas of the Baltic Sea, shores with reed beds are important propagation areas for fish species, because they offer sheltered places for spawning and for the fry. Best areas for the fish offspring are early warming, densely vegetated and wide reed shores where salinity levels are low. There are no other vegetatively suitable places in the Northern Baltic Sea in the early spring (Kallasvuo et al. 2011, 13). Usually offspring of ten different fish species are found in reed shores. Cyprinids form the most significant group, but reed beds are important propagation areas for pikes and burbot also (Kallasvuo et al. 2011, 1). In spring time, pikes are the ones to arrive first in reed beds. Pike's spawning and hatching happen generally in the early May, before the new reed has developed. Pikes spawn on reed that has been cut by ice, fallen down and built up to shallow water. The fry keeps hiding there for the greatest part of their first summer. Also burbot need the fallen reed of the previous year. In winter, burbot spawns to the estuaries from where the fry moves to reed shores at the same time when the ice leaves. Fallen reed is a good habitat for the zooplankton, which is important nutrition of the fry (Härmä 2007, 46). When the new reed zone begins to grow in May, the fry of roach, spiked fish, bream and bass hatch. In June, the fry of rudd, bream, bleak and gobies appear in the new reed growth. The abundance of offspring in the new-grown reed bed is at its highest in the early June (Kallasvuo et al. 2011, 6–7).

Insects

Plenty of insects live in reed beds and some of these species are also numerous, especially many species of mayflies, dragonflies, midges and caddis flies.

Among butterflies and chafers are several species that are dependent on reed beds, but there is not much knowledge about the specific requirements of most species concerning reed beds. However, the large insect concentration in reed beds is important source of food to many fishes, birds, bats and spiders. (Mannerkoski et al. 2007, 36)

In reed beds or coastal meadows bordering them live somewhat plentiful and versatile populations of butterfly species. Some of them are extremely demanding concerning their habitat, whereas others accept almost any wetland that has enough nutrition to offer. For butterflies, the best habitats are sparse reed beds with a gravid and relatively dry bottom and plenty of other herbaceous vegetation. Of the species tied to reed beds, the most demanding is an endangered noctuid that is encountered only in dry-bottomed and sparsely reed-growing environments and low grown parts of vast reed beds. In thick and high reed beds there are not many butterfly species, but the species that live in them appear being plentiful. These species include noctuids and snout moths. In thick, contiguous reed beds lives also the reed leopard. In the reed beds that grow in water or are regularly flooded, lives only few butterfly species that are specialized into wet conditions. On the meadows bordering reed beds lives clearly more butterfly species than in the actual reed beds. (Mannerkoski et al. 2007, 37-39.)

Caddisflies also benefit from the opportunities provided by reed beds in many ways, for dense reed growth effectively restraints the power of waves. For the larva it is important to build a shelter from a piece of reed stem. It diminishes the predation pressure caused by fishes and many insect predators. (Mannerkoski et al. 2007, 39)

Not many beetle species are found to be tied to common reed. Two species most clearly specialized in using reed as a nutrient plant are two species belonging to beetle family of *Chrysomelidae*. In addition, some predator beetles have specialized in living primarily in reed beds. However, reed beds have importance for significantly larger group of beetles. Many less specialized species that appear in growths of sedges, cattails and alkaligrass live in reed beds, too. On the other hand, the spreading of reed has a harmful effect towards many species and even whole beetle communities. On open and low-grown coastal meadows lives a diverse beetle population, but when

the vegetation begins to close up, these species disappear rather quickly, at the latest when reed occupies the meadow. Also many beetles living in the water suffer from the thick reed bed, even though the sheltered ponds that arise in the beginning of the reed growth can be beneficial habitats for them. (Mannerkoski et al. 2007, 36)

References

- Armstrong, J. 1978. Root aeration in the wetland condition, p. 269-297. Book: Hook DD, Crawford RMM (ed) Plant life in anaerobic environments. Ann Arbor Scientific Publication.
- Bart, D., Hartman, J. 2000. Environmental determinants of *Phragmites australis* expansion in a New Jersey salt marsh: an experimental approach. *Oikos* 89: 56-69.
- Below, A., Mikkola-Roos, M. 2007. Ruovikoiden ja rantaniittyjen hoidon merkitys linnuille. – Book: Ikonen, I. & Hagelberg, E. Ruovikot ja merenrantaniityt. Luontoarvot ja hoitokokemuksia Etelä-Suomesta ja Virosta. Lounais-Suomen ympäristökeskus. Turku.
- Björk S. & Granéli W. 1980. Energivass, rapport etapp I, Projektresultat NE 1980:12, Nämnden för energiproduktionsforskning, Stockholm, p 77, in: Ellenberg, H., Weber, H.E., Dull, R., Volkmar, W., & Paulissen, D. 1992. Zeigerwerte von Pflanzen in Mitteleuropa. *Scripta Geobotanica* 18:1-258.
- Eloranta, P. 2005. Järvien kunnostuksen limnologiset perusteet. In: Ulvi, T., Lakso, E. Järvien kunnostus. Suomen ympäristökeskus, Helsinki.
- Eriksson, P., Weisner, S. 1998. An experimental study on effects of submersed macrophytes on nitrification and denitrification in ammonium-rich aquatic systems. In: *Limnology and Oceanography* 44(8) 1993-1999.
- Erkinaro, M., Nieminen, M., Sulkava, R., Terhivuo, J. 2007. Ruovikoihin liittyvät luontodirektiivin liitteen IV eläinlajit Suomessa. Book: Ikonen, I. & Hagelberg, E. Ruovikot ja merenrantaniityt. Luontoarvot ja hoitokokemuksia Etelä-Suomesta ja Virosta. Lounais-Suomen ympäristökeskus. Turku.
- Graneli W., Weisner S., Sytsma M. 1992. Rhizome dynamics and resources storage in: *P. australis*. *Wetl. Ecol. Manag* 1: 239-247.
- Güsewell, S. 2003. Management of *P. australis* in Swiss Fen Meadows by Moving in Early Summer. – *Wetlands Ecology and Management* 11 (6): 433-445.
- Huhta, A. 2008. Rantojen kaunistus vai kauhistus – järviruo'on (*Phragmites australis*) merkitys vesien laadulle. Turun ammattikorkeakoulun puheenvuoroja 41. Turku.
- Härmä, M. 2007. Ruovikot kalojen lisääntymisalueina rannikkovesissä. Book: Ikonen, I., Hagelberg, E. Ruovikot ja merenrantaniityt. Luontoarvot ja hoitokokemuksia Etelä-Suomesta ja Virosta. Lounais-Suomen ympäristökeskus. Turku.
- Ikonen, I., Hagelberg, E. 2008. Etelä-Suomen ruovikkostrategia. Esimerkkeinä Halikonlahti ja Turun kaupungin rannikkoalueet. Lounais-Suomen ympäristökeskus. Turku.
- Ikonen, I., Hagelberg, E. 2007. Ruovikot ja merenrantaniityt. Luontoarvot ja hoitokokemuksia Etelä-Suomesta ja Virosta. Lounais-Suomen ympäristökeskus. Turku.
- Isotalo, I., Kauppi, P., Ojanen, T., Puttonen, P., Toivonen, H. 1981. Järviruoko energiakasvina. *Vesihalitus, tiedotus numero* 210.
- Jalas, J. 1958. Suuri kasvikirja 1. Järviruoko p. 349-352.
- Kallasvuo, M., Lappalainen, A., Urho, L. 2011. Coastal reed belts as fish reproduction habitats. *Boreal. Env. Res.* 16: 1 – 14.
- Karunaratne, S., Asaeda, T., Yutani, K. 2004. Shoot regrowth and age-specific rhizome storage dynamics of *Phragmites australis* subjected to summer harvesting. *Ecological Engineering* 22: 99-111.

- Kääriäinen, S & Rajala, L. 2005. Vesikasvillisuuden poistaminen. Book: Ulvi, T., Lakso, E. Järvien kunnostus. Suomen ympäristökeskus, Helsinki.
- Mannila, J. 2006. Metaani – se toinen kasvihuonekaasu. Helsingin Sanomat 21.11.2006.
- Mannerkoski, I.; Nupponen, K.; Rinne, A., Nieminen, M. Ruovikoiden hyönteiset. Book: Ikonen, I., Hagelberg, E. Ruovikot ja merenranta-niityt. Luontoarvot ja hoitokokemuksia Etelä-Suomesta ja Viirosta. Lounais-Suomen ympäristö-keskus. Turku.
- Native genotype of the common reed, *Phragmites australis*, into North America. – Proceedings of the National Academy of Sciences of the USA 99: 2445-2449.
- Paavilainen, P. 2005. Järviruo'on hyötykäyttö kosteikoissa haja-asutuksen jätevesien ja maatalouden valumavesien puhdistuksessa. Opinnäytetyö. Turku: Turun ammattikorkeakoulu. Kestävä kehitys.
- Pokorny, J. & Kvet, J. 2003. Aquatic plants and lake ecosystems. P. 309-340. Teoksessa The Lakes Handbook vol 1. Blackwell Publishing.
- Pitkänen, T. 2006. Missä ruokoa kasvaa? – Järviruo'koalueiden satelliittikartoitus Etelä-Suomen ja Viirön Väinämeren rannikoilla. Turun ammattikorkeakoulun puheenvuoroja 29. Turku: Turun ammattikorkeakoulu.
- Roosaluste, E. 2007. The reed itself. Teoksessa: Ikonen, I. & Hagelberg, E. Reed up on reed. Lounais-Suomen ympäristökeskus. Turku.
- Saltonstall, K. 2002. Cryptic invasion of the non-Native genotype of the common reed, *Phragmites australis*, into North America. – Proceedings of the National Academy of Sciences of the USA 99: 2445-2449.
- Saltonstall, K. 2003. Recent Research on *Phragmites australis* in North America: Implications for Management. Proceedings of the Aquatic Invaders of the Delaware Estuary Symposium, Malvern, p. 12-15.
- Schröder, S. 1979. The decline of reed swamps in lake Constance. Symposium, Biologia Hungaria 19: 43-48.
- Valste, Juha 2005. Suomen luontotieto A-Kar. Porvoo: WSOY.
- Van der Putten, W. 1997. Die-back of *P. australis* in European wetlands: an overview of the European Research Programme on the Reed Die-Back and Progression (1993-1994). Aquatic Botany 59: 263-275.
- Väre, H., Erävuori, L., & Degerman-Fyrsten, A. 2004. Veden varassa, Suomen vesiluonnon monimuotoisuus. p. 113-188. Edita, Helsinki.
- Weisner, S. & Strand, J. 2002. Handbook of Lake Restoration, Ecology and management of plants in aquatic ecosystems, pp 243-256. Perrow, R. & Davy, A. Cambridge University Press

2. About the Use and Protection of Reed Beds

Kaja Lotman, the Environmental Board of Estonia, **Aleksei Lotman**, the Estonian Fund of Nature

Extensive and golden in spring reed beds are valuable habitats for many species. Reed beds ensure also biological self-cleaning of nature, because the submerged reed roots consume nutrients directly from the water. Too intensive use of reed beds or continuous reduction of reed bed areas may result in the loss of the habitats of certain species and decrease the self-cleaning ability of water bodies. At the same time there are also such species whose habitats are threatened by reed overgrowth. In addition, it should be taken into account that reed is also a valuable renewable resource. Therefore finding balance between the protection of reed beds and other nature values is ultimately important.

The reed beds are widespread both in freshwater bodies and brackish water bodies in the coastal sea. Reed populates quite fast the ponds and ditches and other water bodies. Reed has adapted to live in shallow water, as well as on occasionally flooded land. A reed bed with its overgrown unused stems may eventually become sparse. On old decaying reed stems (reed mat) a new vegetation layer may develop and shrubbery could start growing on it. In case of long-lived intact reed beds, the decay of the habitat quality of species adapted to live in reed beds has been observed. Through the years people have used reed beds in many ways. Moderate reed cutting for thatching or other purposes has maintained the reed fields and preserved good nesting conditions for birdlife in reed beds as well. How do ensure good maintenance and protection of reed beds that would provide biodiversity and self-cleaning ability of nature and high-quality raw material to people?

Legislation regulating the use of reed in Estonia

The Sustainable Development Act (RT I 1995, 31, 384), which defines the notion of renewable natural resource, appoints that for ensuring sustainable development, the Government of the Republic has to determine maximum allowable use as well as its critical reserve. Unfortunately the Sustainable Development Act has not been consistently

implemented and reed is one of those renewables the degree of the use of which has not been regulated.

So the use of reed has not been regulated directly by other means than the Nature Conservation Act (RT I 2004, 38, 258) with the restrictions of activities in protected areas or riparian zones of water bodies. In the protected areas the approach is different for protected reed-bed habitats and reeds encroaching on the semi-natural habitats. In the latter case the objective is to clear sites from the reeds by mechanical means and/or grazing. In Estonia the distribution of semi-natural areas can be found in the public map application of the Land Board (<http://xgis.maaamet.ee/xGIS/XGis> >looduskaitse ja natura>pool-looduslikud kooslused).

The Water Act (RT I 1994, 40, 655) specifies the water protection zone, which stretches 10-20 m from the waterline of different water bodies. In the water protection zone economic activities are prohibited. However, in 2010 an amendment allowing reed cutting has been made.

In the Estonian Nature Conservation Act the most complicated regulations concern Special management zones (only strict nature reserve zones where the regulation is simple are more strictly protected: any use of natural resources is completely prohibited). The Nature Conservation Act stipulates habitat management in the Special management zones according to the protection objective, including reed harvesting that can also be allowed with the protection regulation. However, in case the reed harvesting is not mentioned in the protection regulation of the given protected area, its harvesting in the Special management zone is prohibited. In the least regulated zone – limited use zone – reed harvesting from the unfrozen surface is not allowed if the regulation does not specify otherwise, in other words if the protection regulation of the protected area in the limited use zone does not include reed harvesting, reed can be harvested only from the frozen surface.

Reed harvesting is not directly regulated with the 2004 Nature Conservation Act (RT I 2004, 38, 258) for the so called conservation areas (a category in the Estonian Nature Conservation Act meant to protect these parts of Natura 2000 network that are not designated as protected AREAS), but a general regulation has been established to protect the targeted habitats of the conservation area. We have conservation areas aimed at protecting the habitats for reed birds, for example the bittern, marsh harrier, etc. Therefore the reed harvesters in these areas should consider the fact that though there is no need to request a permit from the authorities, the authorities may prohibit the activities if reed harvesting damages or disturbs the protected species considerably.

The Environmental Board of Estonia draws up protection management plans both for the protected areas and conservation areas. These documents outline the conservation values of the given area and threats that endanger the values as well as management measures needed to preserve the values. In order to avoid misunderstanding by the authorities, the businessmen interested in the use of reed should participate in the public meetings during preparation of management plans or obtain sufficient information about this reed harvesting area, including the protection regime, values and permitted activities.

In Estonia reed grows both on private and public lands, including the lands where land reform process is still ongoing. Reed as a resource growing on a piece of land belongs to the owner. Reed is, differently from mushrooms or wild berries NOT covered by the so-called everymans' right. Therefore the reed harvester should obtain consent from the property owner. The authorized agencies of public lands can be, for example the State Forest Management Centre or Land Board. For the use of unreformed land the county governor gives a permit if it is specified as a semi-natural area or agricultural land. In other cases the governor is not authorized to give rights for land use.

Nature conservation related European Union (EU) directives

A reed bed as a separate habitat has not been listed in the EU Habitat Directive Annex I

(www.natura2000.envir.ee/files/doc/elupaigad.pdf).

However, it should not be interpreted in such a way that reed beds should not be protected within the Natura 2000 network, because it is an integral part of the several habitat types in Annex I. Here such habitat types as river estuaries (1130), coastal lagoons (1150*), large shallow inlets and bays (1160) and natural eutrophic lakes (3150) must definitely be listed. The reed spreading on coastal meadows (1630*) and other semi-natural communities is on the other hand an evidence of poor maintenance. Annex I to the Bird Directive

(www.natura2000.envir.ee/files/doc/eestilinnud.pdf)

mentions several species who have adapted to living in reed beds: bittern, marsh harrier, bearded tit, reed bunting, etc. On the other hand, there are such species in the list for which the overgrowth of reed in their habitats is an essential risk factor, such as dunlin and ruff. Thus the status of reed beds in the Natura 2000 areas depends on what is protected there. For the protected birds living in reeds the vast reed beds growing in shallow water are in particular suitable. Bittern could be considered the best indicator species of reed bed conditions.

Bittern (*Botaurus stellaris*) as a good indicator species of reed bed condition

What is the best type of reed bed for the bittern habitat?

1. Shallow flat-bottomed freshwater bodies where the water does not dry out in summer;
2. At least 20-25 ha of continuous blocks of reed interrupted by small deeper puddles while the area is not overgrown;
3. Smaller reed patches are suitable only in case they are connected to larger reed bed systems;
4. The system of small ponds should make at least 20% of reed bed in order to provide sufficient nutrition basis for bitterns. Bitterns feed predominantly at the 15 m wide edge of reed. Therefore the reed bed should have a

mosaic pattern and reed patches should alternate with reed-free rich of fish ponds;

5. Suitable water depth for the feeding area is 10-25 cm;
6. The water in the water body should not be too eutrophic.

The presence and abundance of bittern in reed beds is estimated by the count of booming males. In twilight

the males become active and make booming calls that resemble blowing into an empty bottle, trying so to attract females. Since the reed bed pattern that bittern prefers is also suitable for many other species adapted to wetlands (marsh harrier, water rail, etc.), the estimation of the number of loud-voiced bitterns gives a good overview of the potential biodiversity of reed beds.



Figure 2.1. Reed bed rich in life (drawn by Elen Apsalon, idea from Ilona Lepik)

Let us consider whether the human interest in mowing and using reed can be reconciled with the development of biodiversity of reed beds. Bittern lives quite comfortably in the areas where the reed is cut either over a year or over 3 years. Therefore, care should be taken that reed is not cut over extensive areas at the same place every year. Also the mosaic of

shallow water and open water between reed patches is essential for the bittern that can mostly be found in non-overgrown reed beds. Figure 2.1 – Reed bed biodiversity – shows the aspects that would provide both the habitat diversity in reed beds and good maintenance of coastal meadows by grazing. Such a landscape can be shaped in cooperation with reed harvesting companies. It has been observed that also

for many other species their abundance is particularly high at the waterline of high reed beds. At the same time there is no point to put excessive restrictions to cutting reed growing on dry land where rather restoring the meadows should be fostered.

Requirements to the use of reed beds in the protection areas

Timing of reed bed management

The national legislation on the use of nature should regulate harvesting of reed beds rich in life in such a way that during the birds nesting time the reed beds are not used and thus the birds can bring their offsprings up safely.

Under Estonian conditions the autumn rains turn the shores of water bodies very soft and travelling by motor vehicles can destroy the surrounding turf meadows and reed rhizomes; a motor vehicle may become stuck in soft soil and there can be a risk of fuel leakage. Therefore, in Estonian nature reserves cutting reed from unfrozen surface or in the ice-free water bodies is predominantly prohibited. The Seiga-type harvesters with wide tyres exercise indeed essentially lower unit stress on the surface than standard tractors. At the present time, however, the legal regulation does not take always in to account the newest technological solutions.

It is essential to ensure that the reed already cut and especially when bound into sheaves would be removed to a higher place in time, because the spring floods may unexpectedly ruin the harvest.

How to cut?

A high quality reed bed rich in life has a mosaic pattern with alternative patches of open water and old reed (broken or decaying stems) has not formed thick bottom sedimentation. Therefore the reed beds should be maintained in such a way that they are split into cutting areas to be harvested over a year or every 3 years. The areas of clearing reed beds should not be too extensive, i.e. over 20 ha. It happens frequently because of weather conditions that reed cannot be cut: winter is not cold enough for forming the ice cover, or the snow cover is too thick and snow bends the reed. There are such winters too when icing takes place in multiple layers and in this case also cutting

and getting the reed is rather complicated, or even impossible.

It is very important that the cut reed is taken away from the cutting area as soon as possible to avoid gathering of reed debris that would prevent mowing next year, reduce the reed quality and may spoil the habitat environment.

It has happened in the nature conservation activities that the workers responsible for reed cutting have not inspected the site properly at the end of the season and sheaves tying cords, oil cans or other devices and tools can be found left behind. Such negligence is unacceptable and may result in suspending reed use rights. In public lands the compliance with the reed cutting agreement can be checked by an authorized body of the public lands. In Estonia the compliance with the reed cutting permits can be inspected by the Environmental Board and violations handled by the Environmental Inspection.

Some cooperation options could be found between the reed harvesting for commercial purposes and nature conservation requirements, however, some contradictions that remain can be underlined:

- Short period for reed harvesting (a few months a year, because it is difficult to predict when the ground freezes in winter);
- Lots of reed must remain growing (on half up to two thirds of cut surface area of reed beds) and therefore the harvesting costs have to be calculated carefully. Another reason may be that suitable reed (in particular essential when harvesting reed as a building material) cannot be cut in the suitable time for reed harvesters, or in some years not at all, because the weather and ice conditions are not favourable;
- The cut reed must be taken away from the harvesting area.

Many people find that reed harvesting with considering the nature conservation and economic objectives is not feasible. On the other hand, maintenance of reed beds is essential also for the found, which would ensure preservation of natural

resources and environmentally friendly raw material harvesting. It is possible with good will.

References

Looduskaisteseadus RT I 2004, 38, 258

Veeseadus RT I 1994, 40, 655

Säästva arengu seadus RT I 1995, 31, 384

Eestis esinevad loodusdirektiivi elupaigatüübid.
www.natura2000.envir.ee/files/doc/elupaigad.pdf

Eestis esinevad linnudirektiivi liigid.
www.natura2000.envir.ee/files/doc/eestilinnud.pdf



Reed bed in Väike väin (Photo: K. Lilleste)

3. *Reed as a Building Material*

3.1. *Reed Harvesting for Construction Purposes, Reed's Quality and Harvesting Technology*

Jaan Miljan, EULS Department of Rural Building

Reed as a renewable organic construction material widespread in nature has recently caught the attention of researchers due to the topicality of energy saving and sustainable construction methods.

In construction reed has mainly been used as a material for covering roofs. Since the first half of the 20th century reed has also been used as slath boards to be used under plaster and from the late 1930s also for manufacturing reed insulating boards. Today reed is being used more and more as a noise barrier and heat insulation board. For insulating ceilings and walls reed bales or loose reed can be used.

The good insulation properties of reed straw are ensured by its hollow stems which keep the air inside. In addition, the stem does not absorb water or moisture and thus the reed can be used for additional insulation of timber and log houses, whereas it preserves the main benefit of a log house – vapour and air diffusion through the walls.

Construction reed can be harvested in December and January, when the reed is dry and the leaves have fallen off, the soil is frozen and water bodies are covered with ice. Reed straws to be harvested must be one year old, which means that the area to be harvested must have been cut clean a year before. Reed can be cut and transported till the middle of April, depending on the beginning of the nesting period of birds, the reed yield and the weather conditions. For instance, reed cannot be cut when there is a lot of snow in winter, the thickness of the ice layer on the water bodies is insufficient, there is strong wind or it is snowing or raining. Nowadays most construction reed is harvested with machines, since compared to manual cutting the

capacity of these is hundreds of times greater. The efficiency of harvesters varies. The size of the machine determines the number of people needed to work on it and also the number of bundles harvested per hour. The operation principle of a reed harvester is as follows: the reed is cut and bound into bundles and the bundles are either left on the harvesting area and or collected later, or collected immediately using the reed harvester itself or on the platform attached to it. Of the ten companies in Estonia dealing with reed (Valge 2010) four used a small BCS 662 tractor made in Italy. Three companies used a Seiga reed harvester (Figure 3.1) made in Hungary (Table 3.1). Besides these, self-made harvesting machines assembled from various machines were also used (Figures 3.2 and 3.4).

Of the eight different harvesters, five were constructed so that a platform trailer was attached to the cutter to collect the crop. With the Seiga harvester and most of the self-made machines it is possible to collect bundled reed on the platform, from which the bundles are loaded onto a transport vehicle or dropped near the harvesting area.



Figure 3.1. Seiga reed harvester



Figure 3.2. A reed harvester belonging to OÜ Järveroog with a BCS header mounted on a Paana track-tractor (Photo: K. Akermann)



Figure 3.3. A Polish Reeda reed harvester with a BCS cutter mounted on it (Reeda Reed 2013)



Figure 3.4. Self-made reed harvesters belonging to Thatched Roof OÜ (Photos: Reedroof 2010)



Table 3.1. Comparison of reed harvesters (Valge, S. 2010)

| Reed harvester and manufacturer | Number operating in Estonia | Power kWh | Weight kg | Fuelled by | Drive part | Floata-bility | Collects reed together | Cutter | Harvesting capacity in bundles | No. of workers per machine |
|---|-----------------------------|-----------|-----------|------------|--------------|---------------|------------------------|-----------------|--------------------------------|----------------------------|
| BCS 662 (Italy) | 5 | 7,5 | 240 | D | Wheels 2x2 | - | - | BCS | 1000 | 1 |
| Thatched roof 1 | 1 | 30,8 | 1900 | D | 4x4 | - | + | BCS | 4000 | 2...3 |
| Thatched roof 2 | 1 | 25 | 2500 | D | 2x2 | - | + | BCS | 3000 | 2...3 |
| Paana Järveroog OÜ | 1 | 85 | 3000 | D | Crawler belt | - | + | BCS | 1800 | 2 |
| Volvo BV-202 Rooekspert OÜ | 1 | 108 | 2500 | D | Crawler belt | - | + | BCS | 4000 | 2...3 |
| Tractor and cutter | 2 | | | D | 4x4 | - | - | BCS | 1000 | 1 |
| Seiga 4x4 (Hungary) | 3 | | | D | 4x4 | + | + | BCS | 4000 | 3...6 |
| Tractor, ZAZ engine and cutter FIE V. Hargats | 1 | | | B | - | - | - | Grain harvester | 1000 | 1 |

A machine specifically suitable for the conditions in Estonia is not manufactured anywhere in Europe, but according to the study results the Seiga reed harvester is most suitable. With this machine it is possible to harvest reed on the ice and in shallow water, as well as in boggy areas. This harvester is very powerful and also collects reed together immediately. A disadvantage of Seiga is its high price. The solution used most often was a BCS cutter mounted on various different tractors (Figures 3.2 and 3.4).

When harvesting with a machine it is possible to choose between two different sorting methods also:

sorting near the harvesting area or sorting in a dry storehouse. To achieve precise measurements per bundle a reed bundle binding bench (Figure 3.5) should be used. Each bundle should only contain uniform reed – short and long, coniform and non-coniform reed cannot be packed in the same bundle. The perimeter of one reed bundle is *ca* 63 cm and, depending on requirements, it is 100-220 cm long and bound with two strings (one 10 cm and the other 50 cm from the bottom of the bundle). A bundle of dry reed weighs approximately 4 kg (Sooster 2006).



Figure 3.5. Reed bundle binding bench, on the left in Estonia, on the right in Latvia (Photos: J. Miljan)



Figure 3.6. Reed drying in stacks (Photo: M. Miljan)

Reed can also be stored on base beams placed on the ground near the harvesting area. Wet reed is piled up or placed in stacks (Figure 3.6). Reed dries most effectively in open air. Piles and stacks are made in windy places. The upper layer of a pile is set inclined so as to direct rainwater down. The benefit of this method is that reed can be cleaned and sorted on site and thereafter bound in bundles.

Reed not meeting the quality standards is left behind. This saves time as well as money, as the reed for thatching is transported from the beach straight to the construction site (Sooster 2006).

Bundles bound with the machine and transported to the storehouse must also be unbound for sorting and cleaning. Reed is cleaned of debris, leaves and short straws for the most part manually. However, it is also possible to use a shaft powered by an electric motor or a diesel engine. The shaft is provided with a spike-tooth roller, which cleans the reed of tassels and leaves (Figure 3.7).



Figure 3.7. A machine for cleaning reeds, powered by a tractor engine

Harvested dry reed can be stored long-term in a storehouse. For more convenient storage and transport, reed bundles are packed in rolls (Figure 3.8) and fastened with a steel band. Reed bundles are packed so that there are 25 or 50 bundles per roll. The approximate length of a roll is 235 cm.

In storage, six layers of rolls can be placed one upon the other. In a dry storehouse the reed will remain usable for years. Air circulation in the storehouse is vital.



Figure 3.8. Reed rolls in storehouse in Latvia (Photo: M. Miljan)

The quality of reed as a construction material is influenced by many factors: the growing place of the reed, the weather conditions during harvesting and growing, the harvesting technology, the sorting quality, drying and storage. When used as an insulation material, the result will also depend on the installation quality.

Although sorting reed near the harvesting area and leaving lower-quality reed there saves time, but from the point of view of more economic use of material it makes more sense to use all harvested reed and thus it should be sorted by quality.

The description of reed quality is given by N. Räikkönen as follows: high-quality thatching reed is bright yellow, straight and hard (hard when felt; not brittle). It stands in fairly uniform bunches with an

average length of about 200 cm and an average thickness of 5-6 mm. A high-quality reed stem should be slightly reddish at the bottom. Based on these parameters, reed material has been classified into four classes ranging from prime quality reed to reed unsuitable for thatching. First-class reed material should be homogeneous in structure and no higher than two meters with a basal stem diameter of 5-6 mm, coarse and straight, devoid of old reed stems, the stems of other plants et al. Second-class (good) reed material may also be slightly over two metres long and contain some poor material, but not an excessive amount.

Reed stands that are too tall or too thick or contain poor-quality material cannot be used for thatching and are assigned to the fourth class of (poor) reed material. The material falling between the second and fourth classes is classified as satisfactory and belongs to the third class. Good-quality reed that exceeds two and a half metres is marked as appropriate material for reed mats (Räikkönen 2007: 17-22).

Reed of poor quality can be chopped or crushed and thereafter pressed into reed blocks or used as loose material for insulating enclosures. Reed chips left over as a result of cutting the edges of reed boards can also be used in the same way. If it is not possible to use reed waste as insulation material, it can be used to press pellets, for instance, which can be used for heating. Robust reed grows on sandy, nutrient-poor soil. Furthermore, the plant profits from a continental climate with hot summers and an interruption of the growing season by strong frosts (cp. R. Rodescu: *Das Schilfrohf*). It is assumed that a high concentration of silicate and a low concentration of nitrogen have a positive effect on durability. Scientific research on the correlation of the composition of reed and its durability is underway on both Germany and the Netherlands (Hiss Reet 2013).

3.2. Determination of Thermal Conductivity of Reed in Estonian University of Life Sciences

Martti-Jaan Miljan, Jaan Miljan EULS Department of Rural Building

Data regarding the heat conductivity of industrial construction materials is available from the manufacturers of these materials. Such data is verified by independent laboratories. Regarding natural materials, this information can be found in various literary sources but the presented values often vary. Thus designers often face the problem of which characteristics of natural material can be considered trustworthy and used for calculating heat transmittance of enclosures and which cannot be. In order to compare the heat conductivity parameters of natural insulation materials, foremost with reed as the material being studied in the framework of the Cofreen project, with the same values of industrial materials, several tests were carried out at the Estonian University of Life Sciences. The heat conductivity (λ) of various insulation materials, including reed, was also determined at the engineering physics laboratory of the Department of Rural Building of the Estonian University of Life Sciences. To conduct the test, an environmental chamber, a test wall element, datalogger, heat flux plates, six temperature thermocouples and various heat insulation materials were used. To determine heat conductivity a test wall element was installed in the door opening of the environmental chamber. This was made of two 50 mm foam polystyrene boards (Figure 3.9) bonded together, in which an opening with a size of 300 x 300 mm was cut and which was thereafter filled with the material to be studied. From the side of the environmental chamber the opening was closed with a rigid 2 mm thick board and silicone and water-resistant tape. The 2 mm rigid board installed on the side of the room was fastened with water resistant tape and additionally supported with two point-contact supports. In total 20 different natural materials were studied, amongst others reed chips and thatch boards.

To determine heat conductivity λ the following parameters were measured:

q – heat transfer through a thermally homogeneous test piece (SV) [W/m^2];

T_e – temperature in the climate chamber [$^{\circ}\text{C}$];

T_i – inside air temperature [$^{\circ}\text{C}$].

$$U = \frac{q}{T_i - T_e}$$

Heat transfer was measured with a heat flux plate and temperatures with thermocouples. The locations of the measuring devices are shown on Figure 3.9.

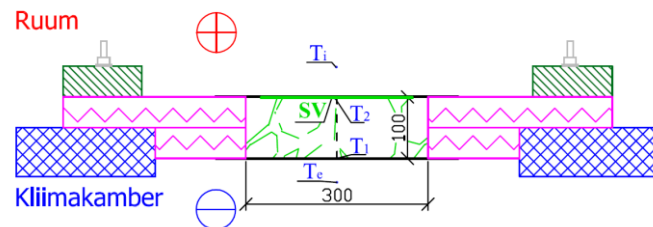

Figure 3.9. Location of measuring devices in the test sample (100 mm)

As one of the characteristic features of heat conductivity is material density, this was determined pursuant to the requirements stipulated in EVS-EN 1602:1999. Thereafter the heat conductivity value λ of the test samples in the test wall was determined (Table 3.2) (Miljan, M-J., Miljan, J. a 2012)

Table 3.2. Density and heat conductivity of various materials tested in climate chamber

| Material | EPS | Isover wool | Hemp fibre | Shavings | Reed chips | Flax fiber | Reed mat | Saw dust | Thermolite |
|-------------------------------------|-------|-------------|------------|----------|------------|------------|----------|----------|------------|
| Density, kg/m ³ | 17 | 30 | 38 | 69 | 76 | 109 | 118.6 | 197 | 254 |
| Heat conductivity, λ (W/mK) | 0.038 | 0.065 | 0.079 | 0.047 | 0.074 | 0.050 | 0.070 | 0.062 | 0.066 |

The test results are not necessarily precise as absolute values but the determined values of heat conductivity of various materials are comparable and as such give an overview of the heat resistant properties thereof. As seen in Table 3.2, the heat conductivity of artificial materials is mostly less than that of natural

materials. Yet the differences are not remarkably large. The results of the heat conductivity led to a study of the heat conductivity properties of reed in an existing wall, since it is known that the heat conductivity of materials in reality differs from their heat conductivity in test conditions.



Figure 3.10. a Cutting of the ends of the reed board



Figure 3.10. b Sewing of the reed board

(Illustrative photos about making reed boards: M. Miljan)

3.3. Determination of Thermal Conductivity of Reed in TRC of Finland

Rauli Lautkankare, TUAS

Many people know that reed is a good thermal insulation material, but cannot say exactly how good it is. Some numeric values can be found in literature and on the Internet, but in this project the purpose was to research the standardized heat conductivity λ of reed as the thermal insulation (Table 3.3).

Testing carried out by the Technical Research Centre (TRC) of Finland provided assertiveness for the results. The test reports are available in Finnish (*test*

test report number VTT-S-01023-12) or English (*test report number VTT-S-01338-12*). The results state that reed has small heat conductivity and is thus a good insulation material. The λ values of the reed's heat conductivity on the right side of the table 3.3. are between 0.049 and 0.058 W/mK.

As a comparison, mineral wools' similar values are between 0.032 and 0.038 W/mK, which means that the differences are 1.5-fold. In other words, 300 mm of reed insulates the same amount of heat as 200 mm

Table 3.3. Heat conductivity of reed insulation (EN 12667)

| Sample/ test specimen | Thickness of the test specimen d (mm) | Wet density/ moisture content Dry density ρ / w (kg/m^3) / (%-from dry mass) | Mean temperature T_m ($^{\circ}\text{C}$) | Temperature difference ΔT (K) | Heat flux density q (W/m^2) | Thermal resistance R $\text{m}^2\text{K}/\text{W}$ | Thermal conductivity λ_{10} $\text{W}/(\text{m}\cdot\text{K})$ |
|--------------------------|--|---|--|--|---|---|---|
| Sample 1 / 1 | 146.4 | 92.2 / 9.8 | 9.96 | 20.06 | 7.90 | 2.54 | 0.0577 |
| Sample 1 / 2 | 147.0 | 88.2 / 10.3 | 9.96 | 20.07 | 7.91 | 2.54 | 0.0580 |
| Sample 1 / 3 | 146.7 | 95.2 / 9.2 | 9.96 | 20.07 | 7.52 | 2.67 | 0.0550 |
| Average | - | 91.9 / 9.8 | - | - | - | 2.58 | 0.0570* |
| Sample 2 / 1 | 134.1 | 87.1 | 10.01 | 20.00 | 7.62 | 2.63 | 0.0510 |
| Sample 3 / 1 | 147.0 | 90.2 | 9.97 | 20.08 | 6.92 | 2.90 | 0.0507 |
| Sample 3 / 2 | 144.7 | 93.9 | 9.96 | 20.06 | 6.81 | 2.95 | 0.0491 |
| Average | - | 92.1 | - | - | - | 2.93 | 0.0500 |

* At equilibrium moisture content after conditioning at $+22^{\circ}\text{C} / 50\% \text{ RH}$.

The estimated uncertainty of the heat conductivity measurements was $\pm 3\%$.

of mineral wool. Reed can be used in building not only as roofing. Reed is an excellent heat and sound insulation which is suitable for walls, base floors and ceilings. Reed can be used in full length and as cut, chopped, baled and ready panels, so called Berger

panels. However, in building, reed is used mostly as roofing. It fits for both traditional and modern style buildings. A 30 centimeters thick reed layer is a significant insulation. It helps to keep the building warm in winter and cool in summer.

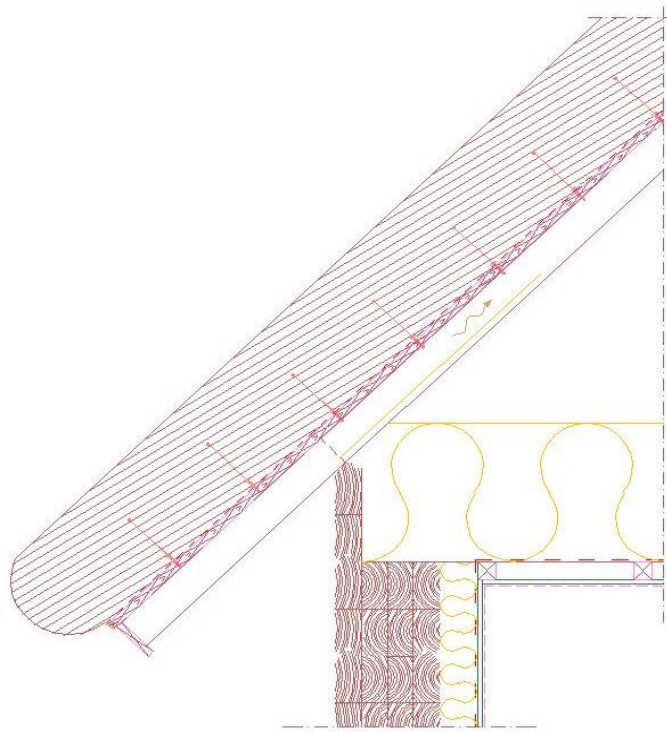

Covering or replacing old roof material with reed
ROOF STRUCTURE

Reed 300 mm
 Old roof cover (bitumen)
 Rough t g boards
 Bearing structure according to requirements
 Ventilated space
 Thermal insulation
 Air and vapour barrier
 Battens c/c 400 mm
 Gypsum board or fire-performance quality
 Surface finishing

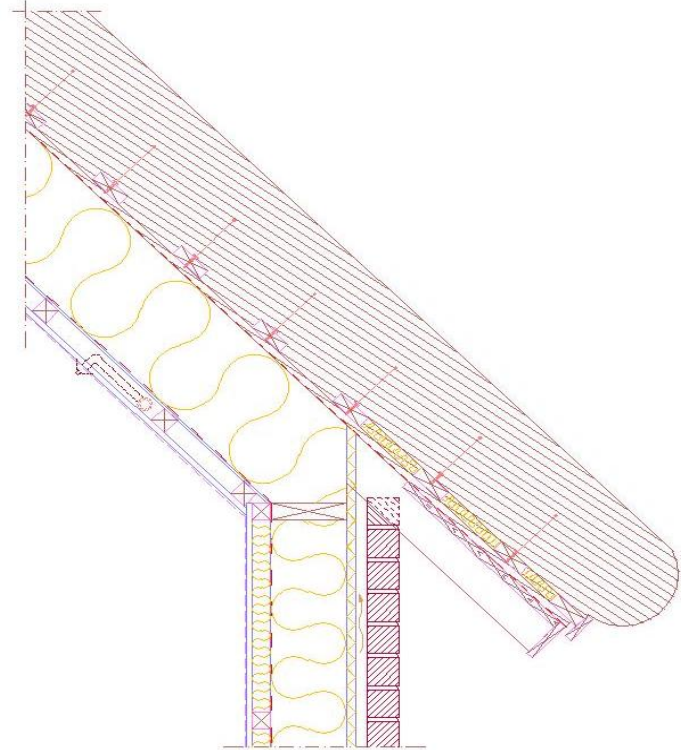

ROOF STRUCTURE

Reed 300 mm, $\lambda = 0,055 \text{ W/mK}$
 Roof battens 32 x 100 mm, c/c 350 mm
 Air gap
 Fire proof underlay
 Bearing structure, beams 300 x 100 mm, c/c 1200 mm
 Thermal insul. 300 mm, $\lambda = 0,033 \text{ W/mK}$ (designed)
 Air and vapour barrier
 Construction board
 2 x gypsum board or 1 layer of fire-performance board
 Surface finishing

Calculated U value = $0,09 \text{ W/m}^2\text{K}$.

Figure 3.11. An example of a ventilated and a non-ventilated roof structure (Picture by R. Lautkankare)

A non-ventilated structure does not dry as fast as a ventilated one equipped with same amount of extra insulation. A non-ventilated structure is better

concerning the energy consumption of the building, because reed provides effective thermal insulation. Also the fire safety is improved with the non-ventilated structures.

3.4. Thermal Transmittance of Wall Fragments Insulated with Reed

Martti-Jaan Miljan, Jaan Miljan, EULS Department of Rural Building

The Department of Rural Engineering of the Estonian University of Life Sciences carried out a test in order to compare the thermal conductivity of used materials of outer walls of different structural solutions. The results of the tests form a basis for consulting people who use natural materials to construct buildings and for giving them specific recommendations as regards the use of certain materials in external enclosures.

In order to imitate the functioning of a structure truthfully in the actual circumstances of the building, measurements on the object were made all year round and the test walls were built in the window openings of the laboratory of building structures. Four different external wall models were built instead of removed windows using natural materials and different structural solutions (Figure 3.12). (Miljan, M-J., Miljan, J. 2012 d)

Test wall S1. A 130 mm thick masonry wall of light clay-flax blocks was built into one window opening. This wall was insulated with hemp chips placed between planks which was covered with 25 mm boarding and was in turn covered with windproof film. An approximately 5 mm thick sparse reed panel was fixed to the inner surface of the wall. The wall was then plastered with clay inside and outside.

Test wall S2. Into the next window opening vertical boards were installed on the external and internal surfaces of the existing wall. The window opening was filled with horizontally placed loose reed and thickened both horizontally as well as vertically (Figure 3.13). The wall was covered with about 50 mm thick clay plaster both inside and outside.

As the third window opening was bigger two different walls S3 and S4 were built into it. Those walls were 450 mm thick, one half constructed of straw and the other of reed bales. The bales were additionally tightened with plastic strings. The outer and inner surfaces of the walls were covered with 50 mm thick clay plaster.

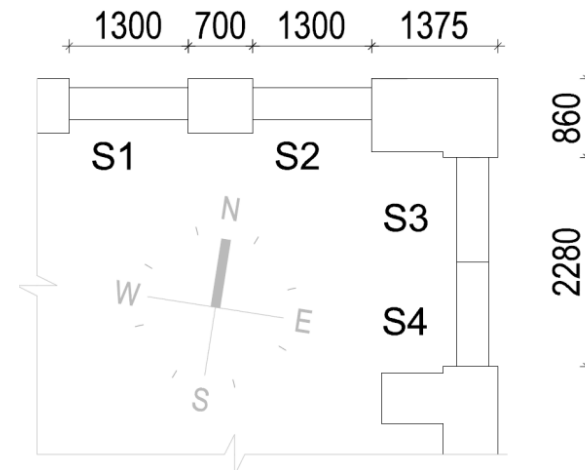

Figure 3.12. Test wall S2, insulated with horizontally placed loose reed



Figure 3.13. Locations of the wall fragments

After the completion and drying of the walls, temperature and humidity sensors were placed inside the wall to measure the characteristics of inner and outer surface and the indoor and ambient air. To measure the heat flux transmitted through the wall, heat flow measuring plates were adhered tightly to the wall (Figure 3.14). All readings were recorded with a 15-minute interval in an Almemo data recorder.



Figure 3.14. Heat flow plates to measure the heat transmittance and thermocouples to measure the air-temperature inside and outside

The following characteristics were measured to determine the thermal transmittance of the wall:

q – heat flow through the wall [W/m^2];

T_e – outdoor air temperature [$^{\circ}\text{C}$];

T_i – room temperature [$^{\circ}\text{C}$].

The formula presented below was used to calculate the thermal transmittance of researched walls.

$$U = \frac{q}{T_i - T_e}$$

Conclusions

(Miljan M-J., Miljan, J. 2012 d)

The test period lasted from December 2009 to May 2011. The measurements were made in a non-steady-state, *i.e.* the temperatures changed continuously in time and hence the heat flow through the wall varied. Data received during the test period with the calculated monthly average values are presented in Figure 3.15. The data shows clearly that thermal resistance is the best in the test wall S2, *i.e.* in the wall insulated with horizontally placed reed, and the worst in the test wall S1, *i.e.* the wall built of light clay blocks insulated with hemp chips.

During the first winter the thermal transmittance decreased remarkably due to the drying of the material (clay plaster). Next year the U-value was already more stable.

Based on test data the average thermal transmittance of the test walls was calculated from October 2010 to March 2011. The results are shown in Figure 3.16.

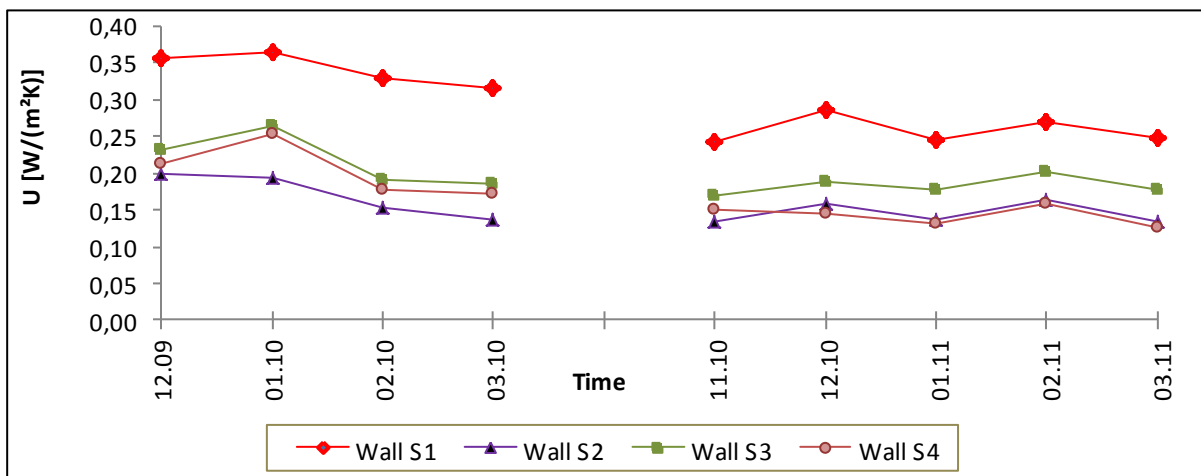

Figure 3.15. The thermal transmittance of different test walls, taking into account the average value in the period from December 2009 to May 2011 (Miljan M-J. 2012 d)

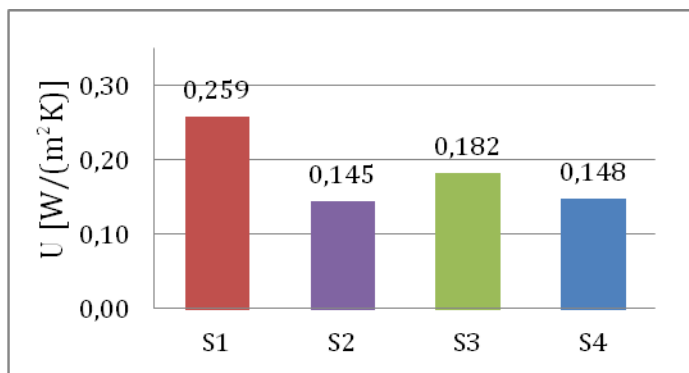

Figure 3.16. Thermal transmittance of test walls

According to the regulation of the Government of the Republic of Estonia *Minimum energy performance requirements* the thermal transmittance value of outer walls must be at least 0,2–0,5 W/(m²K) (RT I:2007). The test results show that only one test wall (S1) does not conform to this requirement, which, taking into account the thickness of test walls, is not at all surprising. Based on the tests carried out it can be said that natural insulation materials compete well with

their insulation characteristics with artificial insulation materials and these can be successfully used in practice. When using local thermal insulation materials one needs to use thicker layers of insulation, but due to the smaller primary energy content of the material we are friendlier to the nature and the emission of greenhouse gases is smaller. In Figure 3.17 is shown the ratio of the percentage of relative air humidity of the walls to the level of saturation as a monthly average value in the period of December 2009 to May 2011.

The values of relative air humidity were measured on the points between of insulation and clay plaster layers in order to see whether the wall structure is saturated with humidity at that point. The line RHe shows RH changes between outside clay plaster and wall structure and the line RH_i shows the same between inside clay plaster and wall structure. Based on the values of the observation period we can conclude that there was no water condensation in the wall structure.

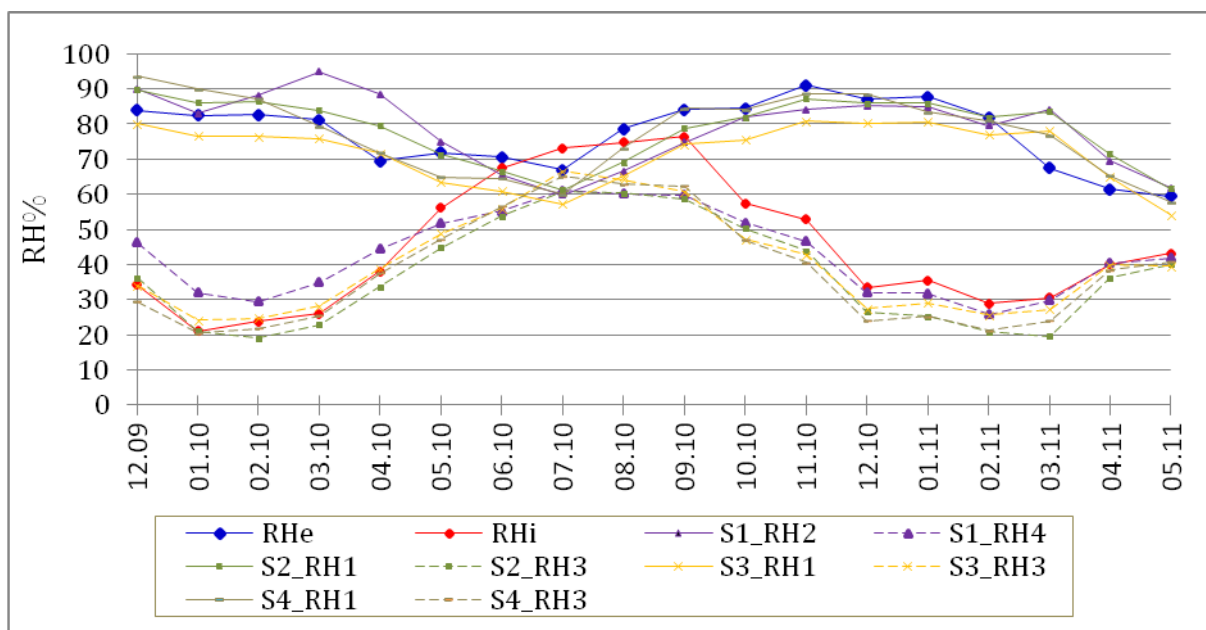

Figure 3.17. The relative humidity of various test walls [RH%], taking into account the average monthly value from December 2009 to May 2011 in the different layers of the walls (Miljan M-J 2012 d)

The investigation of hydro-thermal state done by Wegerer, P., Bednar, T. in 2011, shows also that there was no water condensation inside the wall and

there of no threat of biodegradation of the natural wall insulation materials due to the clay plaster layer.

3.5. Construction of Test House with Reed Insulated Enclosures, Materials and Time Used during the Construction

Matis Miljan, Jaan Miljan, Martti-Jaan Miljan, EULS Department of Rural Building

Construction of the Test House with Reed Insulated Enclosures

The test house (Figure 3.18) was built behind the Estonian University of Life Sciences on the slope of a primeval valley of the *Emajõgi* River in the framework of the Interreg IV A project Cofreen in autumn 2010. The test house was designed by Architrav OÜ according to the ideas and instructions of the department of rural engineering.



Figure 3.18. The Test house

The test house is a timber-framed light building, insulated with reed and finished with clay plaster. The foundation of the house is made of reinforced concrete drilled piles. Half of the house roof is covered with reed and half is covered with wooden

shingles. The reed installed on the ceiling is covered with wind barrier fabric.

The construction of the house was supported by Saviukumaja, MTÜ Savikodu, OÜ Järveroog, OÜ Vennad Ehitus and OÜ Lutike Laast. (Miljan M., Miljan, J. 2012 b)

The plan and cross-section of the building are shown in Figure 3.19, which also depicts the location of the

external walls with different types of insulation. The cross-sections of the walls and floors of the test house are presented in Figures 3.20 and 3.22 while photos of the erected walls are shown in Figures 3.21. a – d. Wall

VS-1 (Figures 3.20. a, 3.21. a) shows a wall with vertically laid reed. Its bearing structure is timber posts with a 50×100 mm cross-section and a spacing of 1600 mm. There are horizontal boards between the posts with a 20×100 mm cross-section and a spacing of 700 mm. For insulation, loose reed was placed vertically, pressed together with securing straps and fixed between the

boards with plastic strings pulled through the reed. Wall VS-2 (Figures 3.20. b, 3.21. b) is a wall with horizontally laid reed. Its bearing structure is made of timber posts with a 50×50 mm cross-section and a spacing of 600 mm. For insulation 350 mm thick loose reed was placed horizontally between the posts. Additionally 50 mm thick reed boards were installed between the frame posts of the longitudinal wall outside and inside.

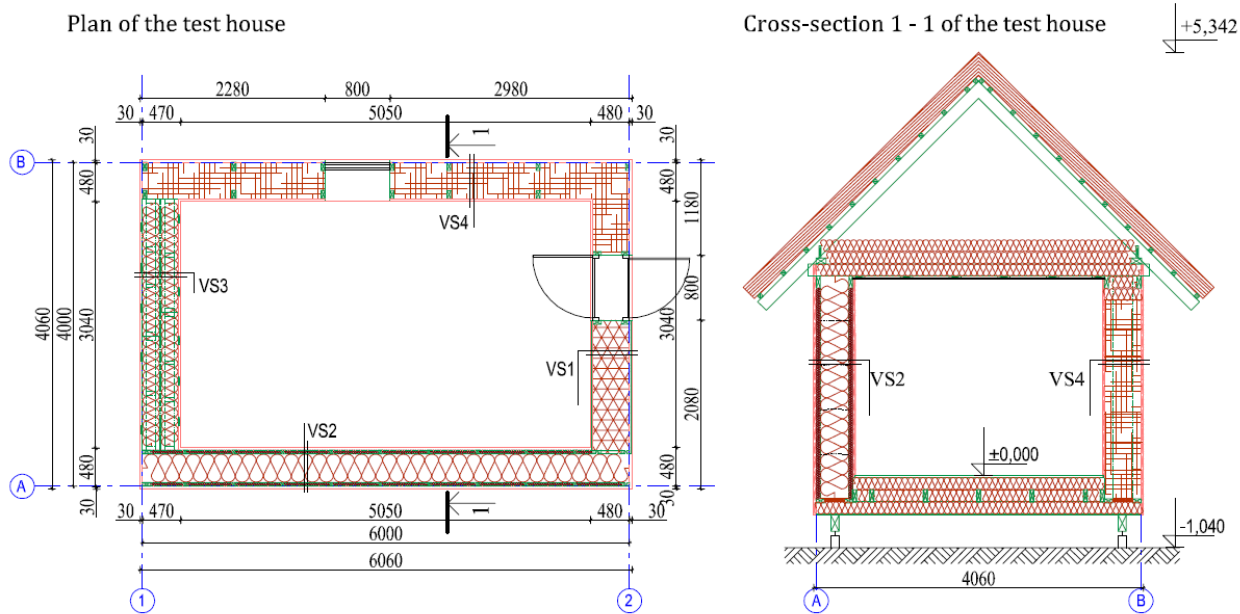
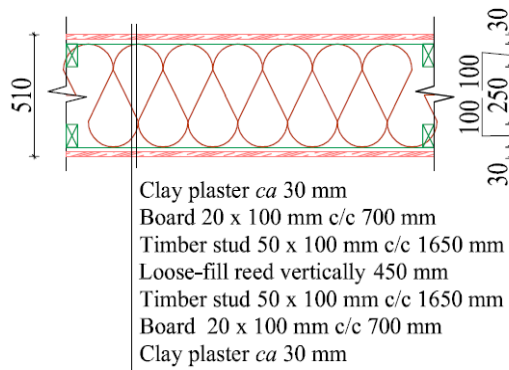
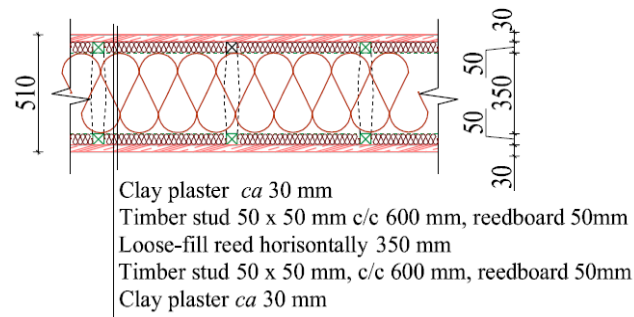

Figure 3.19. Plan and cross-section of test house with reed-insulated enclosures

a) VS-1 - wall with vertically laid reed



b) VS-2 - wall with horizontally laid reed



c) VS-3 - reed panel wall

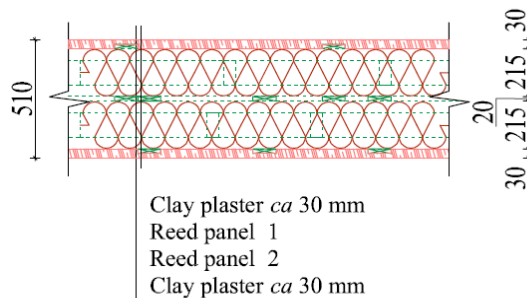

d) VS-4 - reed block wall

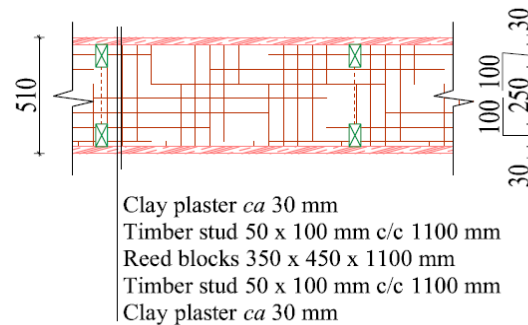

Figure 3.20. Different wall structures of test house



Figure 3.2. a Wall VS-1 (vertically laid reed wall)



Figure 3.2. b Wall VS-2 (horizontally laid reed wall)



Figure 3.2. c Wall VS-3 (reed panel wall)

Wall VS-3 (Figures 3.20. c, 3.21. c) is a reed panel wall composed of two side-by-side reed panels attached to each other. The panels are made of timber frames, one of which is 2,800 mm high and 1,400 mm wide and the other 2,800 mm high and 1,600 mm wide. Both feature 215 mm insulation of horizontally laid reed which has been pressed together, while between the panel layers are placed 20×100 mm timber boards to connect them. The gaps between the central boards are filled with loose reed.

Wall VS-4 (Figures 3.20. d, 3.21. d) is a reed bale wall. Its bearing structure is made of timber posts with a 50×100 mm cross-section and a spacing of



Figure 3.2. d Wall VS-4 (reed block wall)

1,100 mm. The dimensions of the bales are 450 mm thick and 350 mm high. The bales were compressed additionally after every three layers and fixed with plastic strings. The gaps between the posts were filled with loose reed.

The surfaces of the walls of the test house were finished with clay plaster both inside and outside. Photos of the walls during construction and before the plastering are presented in Figures 3.21. a - d.

The floor of the test house was also built using reed as an insulation material. The floor was raised from the ground and the bottom layer of the structure was made of veneer board with a thickness of 10 mm.

This floor area was divided into three parts with different structures. A description of the structures of floors and the finishing layers is given in Figure 3.22.

The structures and the finishing layers of the floors were made as follows:

- 1. Clay floor I.** A floor initially made of reed bales (laid between floor beams) and treated with clay and water mix was covered with a 50 mm layer made of local clay and long reed chips. This part of the floor was compacted and smoothed with a trowel. The floor was left to dry for a couple of days and thereafter a 50 mm layer was installed – a mixture made of local clay and short reed chips. As the cracks that formed during drying were rather big, they were filled with red clay mixed with flax fibre. The final finishing layer was made of a mixture consisting of clay and various different materials.
- 2. Clay floor II.** A floor initially made of reed bales (laid between floor beams) was covered with a layer of local clay, which was

compacted with a wooden ram. As tamping alone was not sufficient to create a homogeneous clay layer, this layer was also levelled with a trowel. When the tamped clay layer had dried, the floor was covered with a mixture made of local clay and short reed chips and a layer of blue clay mixed with short reed chips. These layers were followed by finishing layers.

Clay floors I and II were finished with red and blue potter's clay powder, which was mixed with various materials enhancing bonding. During final finishing a layer of linseed oil and carnauba wax was applied to the clay layer to improve water, wear and frost resistance.

- 3. Clay floor III.** Loose reed was installed between the floor beams. The reed was compressed, fixed and covered with 25 mm boards, which were first covered with *ca* 50 mm thick layer of local clay and thereafter a 50 mm levelling layer made from blue potter's clay powder. For finishing, non-burned clay tiles were used, which were installed using a tile mix.

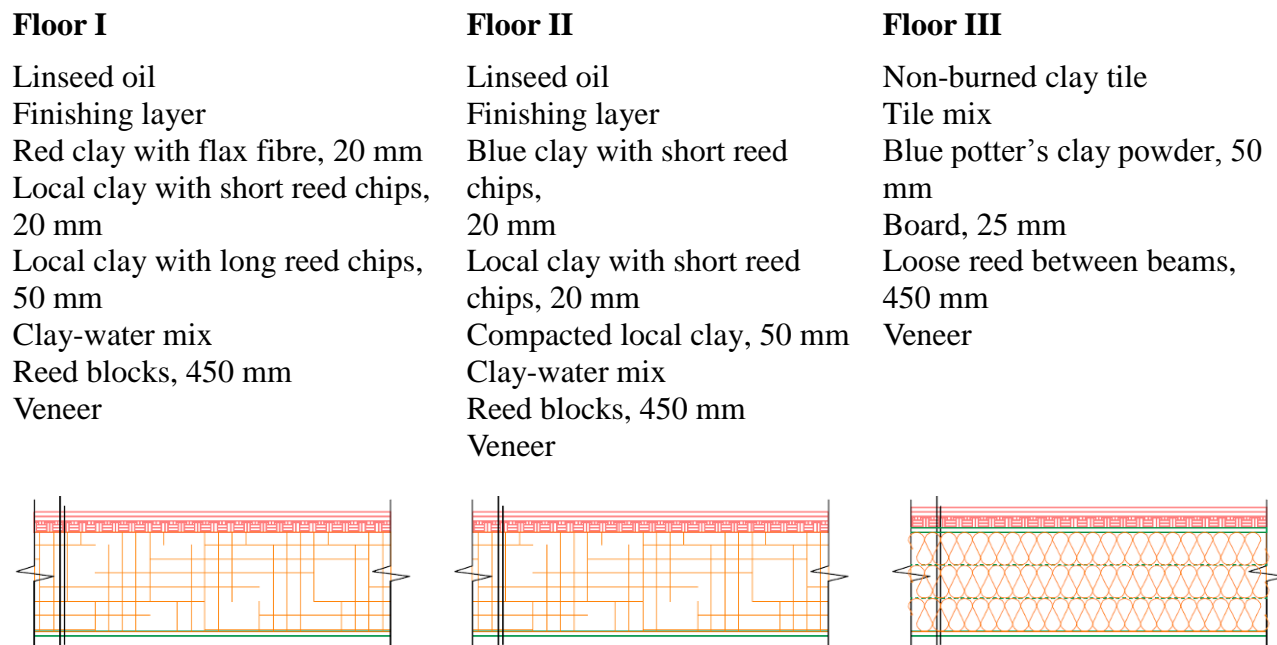

Figure 3.22. Cross-sections of reed-insulated floors

Time Spent and Amount of Materials Used to Construct Walls with Different Structures Insulated with Reed

As we were interested in finding the time spent and the amount of materials used in construction of the

walls, both parameters were measured during the building phase.

The amount of materials used for construction is given to the nearest unit. The material loss that occurred during construction is not taken into account. The amount of materials used per wall and per 1 m² of respective wall is given in Table 3.4.

Table 3.4. Amount of materials used in construction of external walls of test house by walls with different structures and per square metre of respective wall

| Wall's mark | | VS-1 | VS-2 | VS-3 | VS-4 | | |
|-------------------------------|----------------------------------|----------------------------------|----------------------|--------|--------|--------|---------|
| Wall's area in m ² | | 5,0 | 16,8 | 8,6 | 18,6 | | |
| Used materials | Reed board m ² | total | | 31 | | | |
| | | per 1 m ² of the wall | | 1,85 | | | |
| | Reed bundles | total | 72 | 270 | 172 | | |
| | | per 1 m ² of the wall | 14,4 | 16,1 | 20 | | |
| | Reed blocks | total | | | | 38 | |
| | | per 1 m ² of the wall | | | | 2,0 | |
| | cross-section of timber mm | 50 x 50 | Total m ³ | | 0,14 | 0,063 | |
| | | | per 1 m ² | | 0,0083 | 0,0073 | |
| | | 50 x 100 | total m ³ | 0,028 | | | 0,196 |
| | | | per 1 m ² | 0,0056 | | | 0,00105 |
| | | 20 x 100 | total m ³ | 0,024 | | 0,112 | |
| | | | per 1 m ² | 0,0052 | | 0,0013 | |
| Clay plaster kg | total | 538 | 2016 | 1042 | 2242 | | |
| | per 1 m ² of the wall | 108,0 | 120,0 | 121,2 | 120,2 | | |

(Miljan, M., Miljan M-J. 2012 b)

Table 3.4 shows that roughly the same amount of clay plaster is required to finish 1 m² of wall with different structures. The least amount of plaster was used for wall VS-1, as the wall boards were only covered with *ca* 10-20 mm of plaster. The smallest amount of reed bundles (diameter 21 cm) per 1 m² laid in the wall vertically was for wall VS-1 (14.45 bundles). 20 reed bundles per 1 m² of wall were laid horizontally in panel wall VS-3. Also, the largest amount of timber was used to build the panel wall.

The activities carried out were recorded by groups as shown in Table 3.5.



Figure 3.23. Fixing of loose reed with plastic straps in wall VS-2 (Photo: J. Miljan)

Table 3.5. Activities carried out and time measured during construction

| Name of activity | Time spent on construction of walls in hours | | | | | | | |
|--|--|------------------|-------|------------------|-------|------------------|-------|------------------|
| | VS-1 | | VS-2 | | VS-3 | | VS-4 | |
| | Total | 1 m ² | Total | 1 m ² | Total | 1 m ² | Total | 1 m ² |
| Construction of timber frame | 4,0 | 0,9 | 15,1 | 0,9 | | | 16,8 | 0,9 |
| Filling structures with loose reed and fixing it | 12,0 | 2,7 | 51,0 | 3,0 | | | | |
| Covering walls with reed board | | | 15,0 | 0,9 | | | | |
| Placing of reed blocks | | | | | | | 26,0 | 1,4 |
| Construction of reed panels | | | | | 28,0 | 3,3 | | |
| Application of reed panels | | | | | 12,0 | 1,4 | | |
| Preparations for plastering | 1,6 | 0,4 | 6,3 | 0,4 | 3,2 | 0,4 | 6,9 | 0,4 |
| Plastering of walls | 11,8 | 2,6 | 44,2 | 2,6 | 22,8 | 2,6 | 49,2 | 2,6 |
| Total amount of working hours | | 6,6 | | 7,8 | | 7,7 | | 5,3 |

(Miljan, M., Miljan M-J. 2012 b)

From Table 3.5 we can see that the most long lasting works were clay plastering and the construction of panels. As the whole wall should be filled with reed as densely and evenly as possible, to ensure better thermal resistance, this work lasted also quite a lot of time. Loose reed was needed to compress and to fix to the wooden posts (Figure 3.23).

research of Kukka and Miljan (2009) about construction of the walls with a timber siding on both sides, glass wool insulation and timber framework, a bar chart was made, as presented in Figure 3.24.

At this point we should admit that the construction of reed insulated walls comparing with the light-weight walls building takes more time.

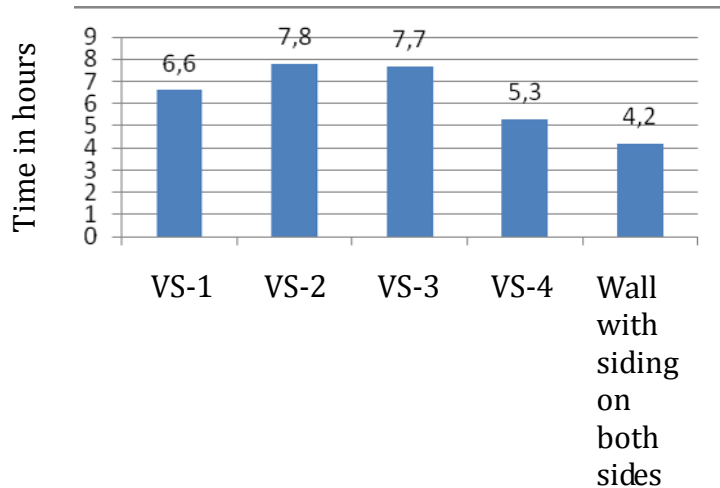

Figure 3.24. Comparison of construction times of reed insulated walls and lightweight wall

Using data from Table 3.5 about the time spent on construction of the lightweight walls insulated with reed and covered with clay plaster and data from the

While the test house was being constructed the least amount of time was taken to erect wall VS-4, which was made from reed bales, as it took just 5.3 hours to build 1 m² of wall. The most time (7.8 h/m²) was spent building wall VS-2, which was insulated with horizontally laid loose-fill reed. Wall VS-3, which was also insulated with horizontally laid reed in panels, was close behind, with a building time of 7.7 h/m².

3.6. Thermal Transmittance of Enclosures of the Test House

Martti-Jaan Miljan, Jaan Miljan, EULS Department of Rural Building

The thickness of the reed layer in test house's enclosures was 450 mm and the walls were rendered with clay plaster inside and outside and the floor was covered with different layers of clay also. Heat flow plates were used to measure the thermal transmittance of walls and floors in the completed house from October 2010 to March 2012. Our aim was to find out are reed-insulated enclosures a competitive variant in comparison of widely used wall's structures considering thermal properties and requirements of Estonian legislation.

To fulfill our aims the following characteristics were measured: (Miljan M-J., Miljan, J. 2012 c)

q – heat flow through wall [W m^{-2}];

T_e – outdoor air temperature [$^{\circ}\text{C}$];

T_i – indoor air temperature [$^{\circ}\text{C}$].

Measurements data were taken and recorded at 15-minute intervals using the data recorder Almemo. Based on the readings from the measuring instruments the thermal transmittance of the enclosures was calculated using the next formula:

$$U = \frac{q}{T_i - T_e}$$

To show how the changing of ambient situation influences the value of thermal transmittance during 14 days period in February 2012, the changes in the thermal transmittance of the external walls were depicted as a graph in Figure 3.25.

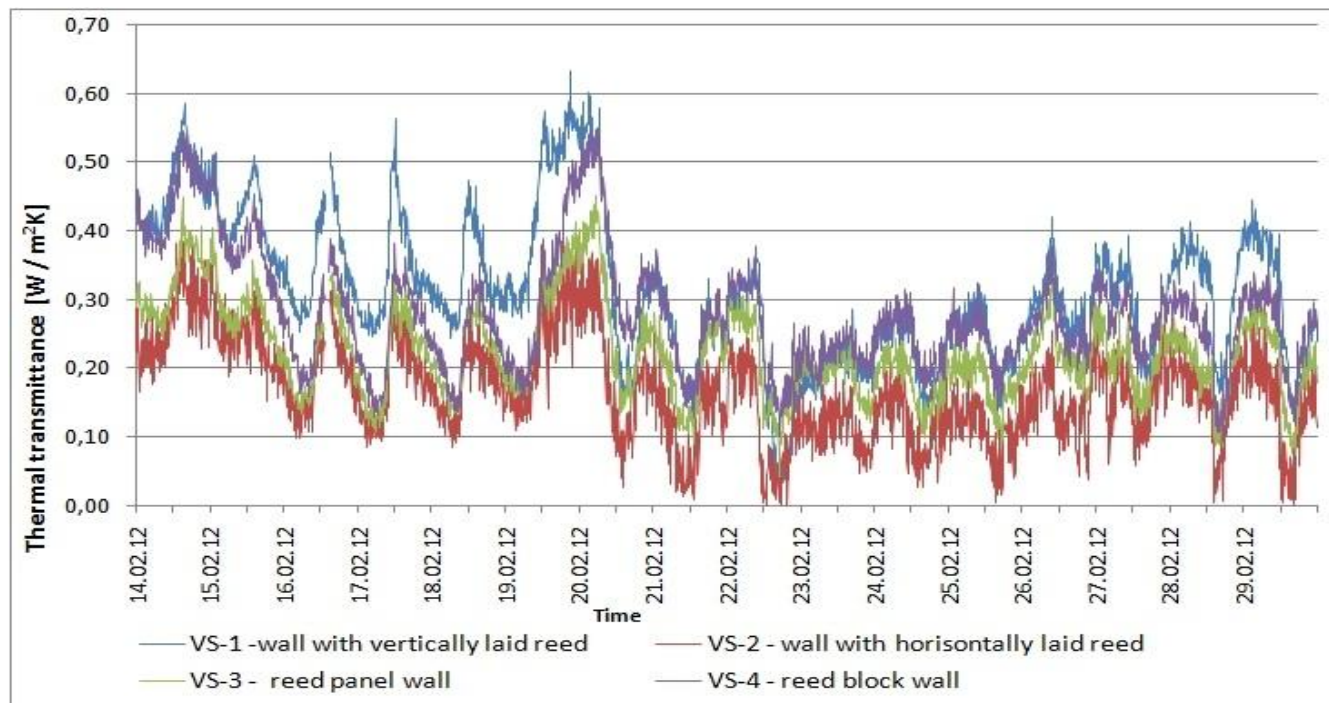

Figure 3.25. Changes in thermal transmittance of different test walls in non-steady environment (2nd half of February 2012) (Miljan M-J. 2012 c)

The average U-values were calculated for the walls with differently laid reed insulation on the basis of the uniform areas in the graph. The results are shown as a bar chart in Figure 3.26.

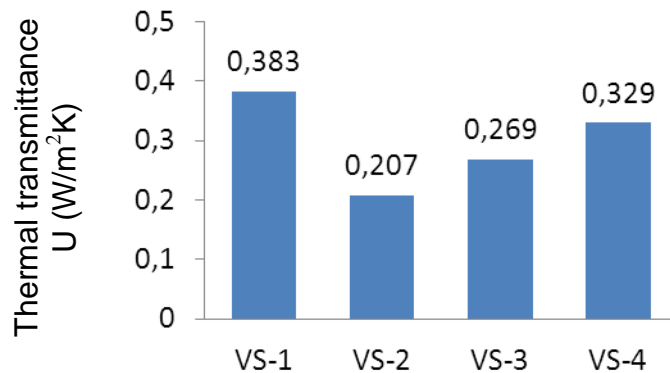

Figure 3.26. Thermal transmittance U of different test walls (February of 2012) (Miljan, M-J., Miljan J. 2012 c).

Figure 3.26. shows that external wall VS-2 has the lowest thermal transmittance with an average $U = 0.207 \text{ W/m}^2\text{K}$ and wall VS-1 has the highest thermal transmittance: $U = 0.383 \text{ W/m}^2\text{K}$.

As all walls had the same thickness, the reed insulation layer was 450 mm everywhere, it can be claimed that the differences between the thermal resistance characteristics were caused by the construction technology and probably also quality. Many studies have referred to differences between the values of thermal conductivity provided by the manufacturer and of the materials installed in the walls. The higher thermal transmittance of wall VS-1, where the reed was laid vertically in the timber framework, may have been due to the fact that the reed stalks and the vertical gaps between them enabled air to move inside the wall and thus heat was transferred with higher convection. As we were unable to compress the vertically laid reed sufficiently, the amount of reed bundles used per 1 m^2 of this wall was the smallest (table 3.4). A clear difference between thermal transmittance values emerges when comparing the vertically and horizontally laid reed. An article about the use of reed (Wegerer & Bednar 2011) which describes the insulation of a wall on the inside using a reed mat as lathing includes a requirement by the manufacturer

that the mat must be placed so that the reed straws are directed horizontally. Unfortunately the requirement was not justified.

When choosing insulation, the basis must be that the external enclosures have low thermal transmittance. When calculating energy consumption in Estonia we must comply with the “Minimum energy performance requirements” as required by RT I 2007, where the value of thermal transmittance (U-value) is $0.2\text{-}0.25 \text{ W/m}^2\text{K}$. Of all the walls in the test house the U-value of the horizontally laid reed wall (VS-2) was the only one in this range. Thermal transmittance of floors was measured shortly from 17.03.2011 until 03.04.2014 and calculations showed that the average U values of the Floor I, Floor II and Floor III were respectively $0,197 \text{ W/m}^2\text{K}$, $0,211 \text{ W/m}^2\text{K}$ and $0,173 \text{ W/m}^2\text{K}$.

References (Parts: 3.1, 3.2, 3.4, 3.5)

Hiss Reet 2013 <http://www.hiss-reet.com/>

Kukka, E., Miljan J. 2009 The most spread outer wall types in Estonia and their primar energy content. Builder pp 64-67 (in Estonian)

Miljan, M-J., Miljan, J. 2012 a Determination of thermal properties of insulation materials in the laboratory of building structures. Compendium of scientific studies of Estonian University of Life Sciences 2012, Local natural building materials and their use. Tartu pp 27-34 (in Estonian)

Miljan, M., Miljan M-J. 2012 b Construction of a test house with reed insulated walls. Compendium of scientific studies of Estonian University of Life Sciences 2012, Local natural building materials and their use, Tartu pp 43-50 (in Estonian)

Miljan M-J., Miljan, J. 2012 c Thermal transmittance of reed insulated enclosures of a test house. Compendium of scientific studies of Estonian University of Life Sciences 2012, Local natural building materials and their use. Tartu pp 51-59 (in Estonian)

Miljan M-J., Miljan, J. 2012 d Thermal transmittance of the walls insulated with natural materials. Com-

pendium of scientific studies of Estonian University of Life Sciences 2012, Local natural building materials and their use. Tartu pp 60-65 (in Estonian)

Valge, S. The Comparison of Reed Harvesting Machines, Bachelor thesis of Estonian University of Life Sciences 2010

Sooster, S. Construction of Roofs Covered with Straw and Reed. OÜ Rooekspert 2005. Käina p39 (in Finnish)

Reeda Harvesters 2013
<http://www.tradekey.com/company/REEDA-harvesters-1381938.html>

Räikkönen, N. Classification of reed beds and reed biomass and quality mapping 2007 – Read up on Reed /Ed. Ikonen, I., Hagelberg, E. Southwest Finland Regional, Environment Centre, 17-21 p

The State Gazette I 2007. 7, 445. The Government of the Republic of Estonia “Minimum energy performance requirement” (in Estonian)

Wegerer, P., Bednar, T. 2011 Long-term Measurement and Hygrothermal Simulation of Interior Insulation Consisting of Reed Panels and Clay Plaster. NSB 2011 pp 331-336



Vaibla reed bed at Vörtsjärve lake (Photo: Ü. Kask)

3.7. The Mold Test

Rauli Lautkankare, TUAS

Common reed is an organic building material. As a natural material, reed becomes mouldy as well as wood or wood-based products in favourable conditions. Jan Bergholm has studied this in his thesis for the degree program of civil engineering (Bergholm 2012).

The sensitivity to form microbe growths on surface of materials such as building-purposed common reed and seven other commonly used building materials was examined in Bergholm's thesis. The purpose was to investigate how well reed will manage in climatic overstress testing when the circumstances are standardized as extremely favourable for the development of moulds. The climatic overstress testing was used as a test method. The tests were

aspired to carry out as similarly as possible concerning material choices, conditions and methods. The building materials apart from reed studied in the thesis were pine, straw, concrete, EPS panel and mineral wool. Some of these materials were found in comparable researches performed earlier. (Bergholm 2012)

Mold indexing table and the mold researches created and carried out by Hannu Viitanen in 1996 (table 3.6) were utilized in the thesis (Viitanen 1996). Research materials were concrete, woodchip panel, EPS panel and mineral wool, which were correspondingly used as comparison objects in Bergholm's study. The changes originating in reed materials were not studied before using a similar climatic over-stress testing.

Table 3.6. Mold indexing classifications.

| Mold index | Description of classification |
|------------|---|
| 0 | No growth, the surface is clean |
| 1 | Mold growth observed with microscope: minimal microbe exposure, some mycelium |
| 2 | Mold growth observed with microscope: modicum growth of mycelium |
| 3 | Mold growth observed with bare eyes: less than 10% covered with mycelium; mold growth observed with TAI microscope: mycelium covers less than 50% of sample |
| 4 | Mold growth observed with bare eyes: less than 50% covered with mycelium; mold growth observed with TAI microscope: mycelium covers more than 50% of sample |
| 5 | Mold growth can be observed with bare eyes, more than 50% covered with mycelium |
| 6 | Abundant growth of mold, almost 100% of sample's surface is covered with mycelium |

Test conditions

Constant conditions - temperature of +22 °C and RH of 90-95% - were used during the overstress test. Therefore, the circumstances concerning temperature

and humidity was favourable for mold development. The purpose of the test was to study the sensitivity and the resistance of materials for microbe growth, i.e. how potential platform the material is for molds. (Bergholm, J. 2012)

The relative humidity of the indoor air varies usually between 20% and 60% in apartments or residential buildings. In this climatic overstress testing, the relative humidity was mainly around 95% in a temperature of +22 °C. This kind of humidity does not practically exist in residences, except at short times, for example during showering. (Bergholm, J. 2012)

Test performance

The research was performed with an Arctest 1500 climatic test chamber (Figure 3.28) in the civil engineering laboratory of Turku University of Applied Sciences. The different building materials placed in the climatic test chamber (Figure 3.27) were exposed to an intense humidity for several weeks. Two or three specimens of each material were tested at the same time. The climatic overstress testing was repeated once. The conditions were the same and few samples with little or no microbe growths were taken also to the second test. The first series of tests lasted for 8 weeks and the second for 17 weeks. The 5 cm x 5 cm sized specimens made from different building materials were placed in their own petri dishes. The same temperature (+22 °C) and relative humidity (90-95 %) were sustained in the climatic test chamber. (Bergholm, J. 2012.)



Figure 3.27. Samples in climatic test chamber



Figure 3.28. ARCTEST 1500 climatic test chamber

The samples of the first test series were taken to a physics laboratory for photographing once in a week. A minimal microbe exposure of the photographer was ensured with an air-conditioned research chamber that was in the laboratory. To ease the transport of the materials, the petri dishes were placed in transparent, plastic cases, four in each case. These were closed during the sample shifts. The cases were also opened for as little time as possible during the photographing to keep the air in the room from affecting the test results. The photographs were taken with a digital camera that was focused through a microscope from a standard distance (Figure 3.29). The photographing was performed weekly and it lasted from half to three hours at a time. The samples of the second test series were photographed once in approximately two weeks. (Bergholm 2012)

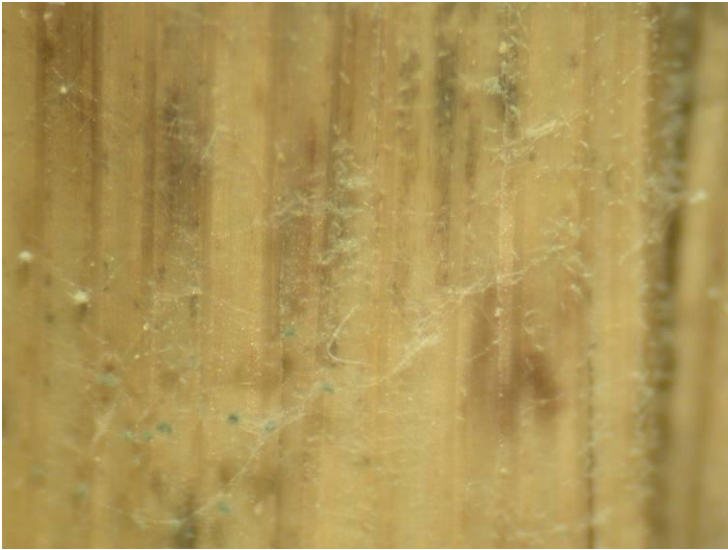

Figure 3.29. A microscope picture reveals mycelium and colonies on the surface of a reed sample

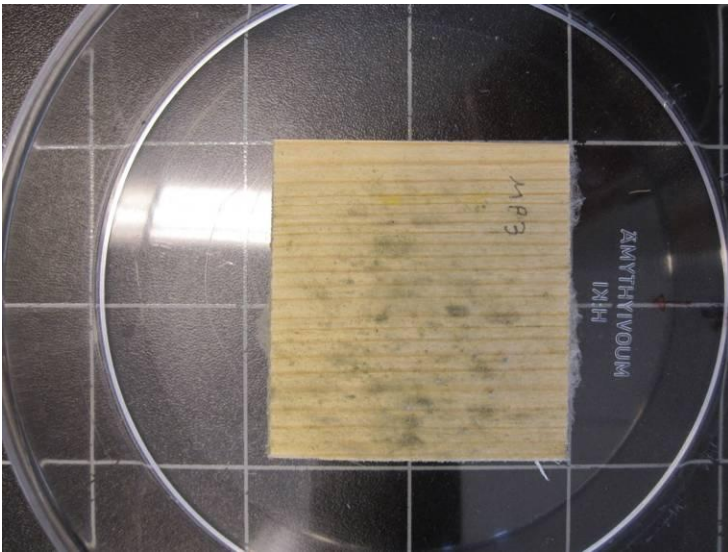

Figure 3.30. Mold growth can be observed with bare eyes on the pine sapwood

Preparing actions between the tests

After two months, the first test was finished. All reed samples were clearly become mouldy when examining them with bare eyes. At this point the test was resumed, because it was mainly concentrating on the reed materials. However, the concrete and EPS panel samples were almost clean from microbe growths after two months of climatic overstress. From this kind of material samples one old sample was taken to

the test number two. These materials included concrete, EPS panel, heartwood of pine and mineral wool. The purpose was to research how the test affects these materials in the long run. (Bergholm 2012)

After the first test, the climatic test chamber was autoclaved for sterilizing it from living microbes. Autoclaving is the test chamber's own cleansing method which was now performed in a temperature of +150 °C with a humidity of 40 %. Autoclaving lasted for six hours, and at this time the used petri dishes were washed and the plastic cases were cleaned with pressurized air. (Bergholm 2012.)

To minimize the margin of error, the digital photos taken from the materials were interpreted by three people independently. Each interpreter was doing mold indexing for the first time, so they lacked a base of experience and comparison. As a result, the margin of error can be considered as +/- 1 unit on the mold index. Some of interpreters could consider actual 50% mold coverage (mold index 4) lesser and give mold index 3. On the other hand, some could interpret it more and give 5 for mold index. The chance of error is compensated by the fact that there were three interpreters. One of them was a teacher, the second an adult student (aged 40 years) and the third one a student (aged 20 years). (Bergholm 2012)

The photo interpretation was complicated because the first-timers did not know what to search for. Some samples were diffuse or opaque to detect, because for example the fiber texture and color of mineral wool were complicating the detection of microbe growths. The light mold mycelium does not stand out from the yellowish fiber background, so they could easily remain unseen. (Bergholm 2012)

When the mold indexing was completed, the numerical values could form a diagram of the mold sensitivity of the building materials (Figure 3.31). The diagram shows that pure natural materials get moldy more sensitively compared to pure stone or plastic products. Reed mildews in the same time than the surface wood of pine, or a basic pine board. It is known that the heartwood of pine does not decay as fast as the surface wood and this test confirmed it. Straw mildewed a little faster than reed and also

gained a vaster mold cover during the test. Concrete has a pH of 10-12 and is thus so alkaline material that microbes do not grow on it. However, at the construction site, dust or sawdust accumulates on the

surface of concrete and this allows microbes to grow relatively fast also on concrete. Hannu Viitanen has studied also this in Technical Research Centre of Finland (Viitanen 2004).

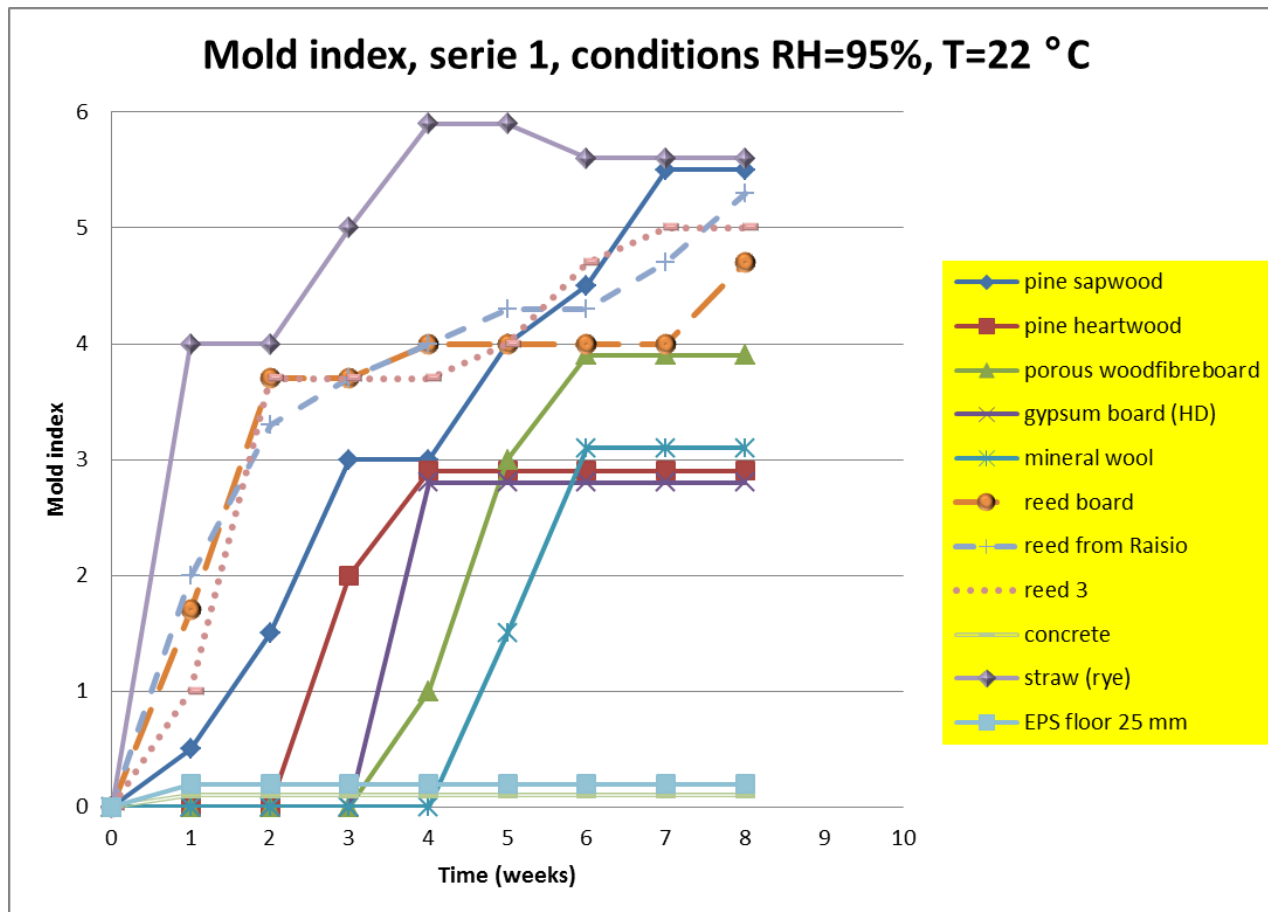

Figure 3.31. The mold index of the building materials as a function of time in the climatic overstress testing

However, natural materials do not overcome well in this kind of tests where conditions stay extreme for a long time. If these conditions appear for longer time periods in practice, there usually is a defect in the building or in the structure. Natural materials have their positive sides. Mostly they are healthy, safe and balancing air humidity and they cause little allergic reactions. A properly made thatched roof lasts for decades. Biological wearing is not a huge problem, but it lays the most important demand concerning the durability and the serviceable life of the thatched roof: a dry layer of roofing. This actualizes when the roof is well made and steep enough.

Bergholm, Jan 2012. Opinnäytetyö, rakennustekniikan koulutusohjelma. TUAS (in Finnish)

Viitanen, Hannu. 1996. Factors affecting the development of mould and brown rot decay in wooden material and wooden structures. Effect of humidity, temperature and exposure time. Docotral Thesis. Uppsala. The Swedish University of Agricultural Sciences, Department of Forest Products

Viitanen, Hannu. 2004. Betonin ja siihen liittyvien materiaalien homehtumisen kriittiset olosuhteet - betonin homeenkesto. VTT Rakennus- ja yhdyskuntatekniikka. (in Finnish)

3.8. The Fire Test of Thatched Roofs

Rauli Lautkankare, TUAS

The fire test of thatched roofs was carried out for studying the fire safety of the roof material. Fire safety is the most important factor concerning having a permission to build a house with a thatched roof. It is also what the building inspector would probably first inquire. Test results benefited the upcoming building instruction card for thatched roofs and provided practical information about thatched roofs' relatively difficult ignition.

The purpose was to research how the fire will spread in the reed roofing, what kind of substructure provides the slowest progress of fire, and which points of the roofing are the weakest and thus need special attention in the designing process. The fire test was arranged on a field of Livia vocational school in Kaarina, Finland in March 2013. The roof's building stages were methodically recorded with a video camera and the video was edited to be a building instruction for a thatched roof on DVD. It can be watched on the project webpage

Test arrangements



Figure 3.32. Siim Sooster guiding the first-timers

For the fire test, three thatched roofs were built on the field next to a road in Tuorla. These were sized 4 x 3 meters, the roof angle was 45 degrees and they were facing to north. Roof structures were constructed differently for each roof. The structure of the roof ridge was traditional: reed lied parallel to the ridge and there were wooden cross spars on the ridge.



Figure 3.33. Petri Iivonen levelling the eave's end with a specific tool.

The roofs were supposed to be built as realistically as possible, even though the purpose was to burn them.

The reed was brought from Estonia and the thatching was led by Estonian roof master Siim Sooster. Two construction management students from TUAS were aggregating the reed structures and two other construction management students were practicing the roofing guided by Sooster. The installation of the roofing was recorded and edited to be the building instruction video.



Figure 3.34. Veli-Matti Saaren-Kierola cutting the reed stalks going over the ridge.

Structures of the test roofs (Figure 3.32)

1. Reed 250 mm
Plywood 12 mm
Rafters 100x50 k 600
2. Reed 250 mm
Battening 50x50 k350
Rafters 100x50 k 600 + eco wool 100 mm
Construction paper
3. Reed 250 mm
Battening 50x50 k350
Fibreglass cloth Sepatec
Rafters 100x50 k600 + Isover glass wool 100 mm
Vapour barrier 0.2 mm

Test conditions

The fire test was carried out on 7.3.2013 starting at 14:00. The day was sunny, temperature was -5°C and the gusty wind was blowing from north. The wind led the fire's spreading in the structures left from the lighting point.

The test was started by lighting all three roofs in fire at the same time. This happened from the down part, in the middle of the eaves and with a gas flame. The voluntary fire brigades of Rantakulma and Kuusisto

were attending. In addition, there was an audience of about 30 persons. The fire event was recorded.



Figure 3.35. The coincidental lighting of the roofs at 14:15.

Passage of the test

- About 10 minutes from lighting, half of the edges were in flames.
- About 13 minutes from lighting, the reed covers of the roofs No 2 and No 3 were in flames.
- About 18 minutes from lighting, roof No 2 was burned down to the earth.



Figure 3.36. A thermal picture of the roof No 1, the lighting is going on

- About 24 minutes from lighting, roof No 1 was tried to extinguish. Left side of the edge was burned.

- About 35 minutes from lighting, roof No 3 was burned down to the earth. The fiberglass cloth was nearly intact.
- There was a hole with a diameter of 10 cm only in a couple of spots in fiberglass cloth.

with the size of the burning roof being 12 m² and other circumstances being like they were. In other kind of a situation, the heat radiation can be considerably greater.

Secondly, even though the reed layer did not burn very strongly and it was partly extinguished by a spout, the charred parts of reed lit again because of

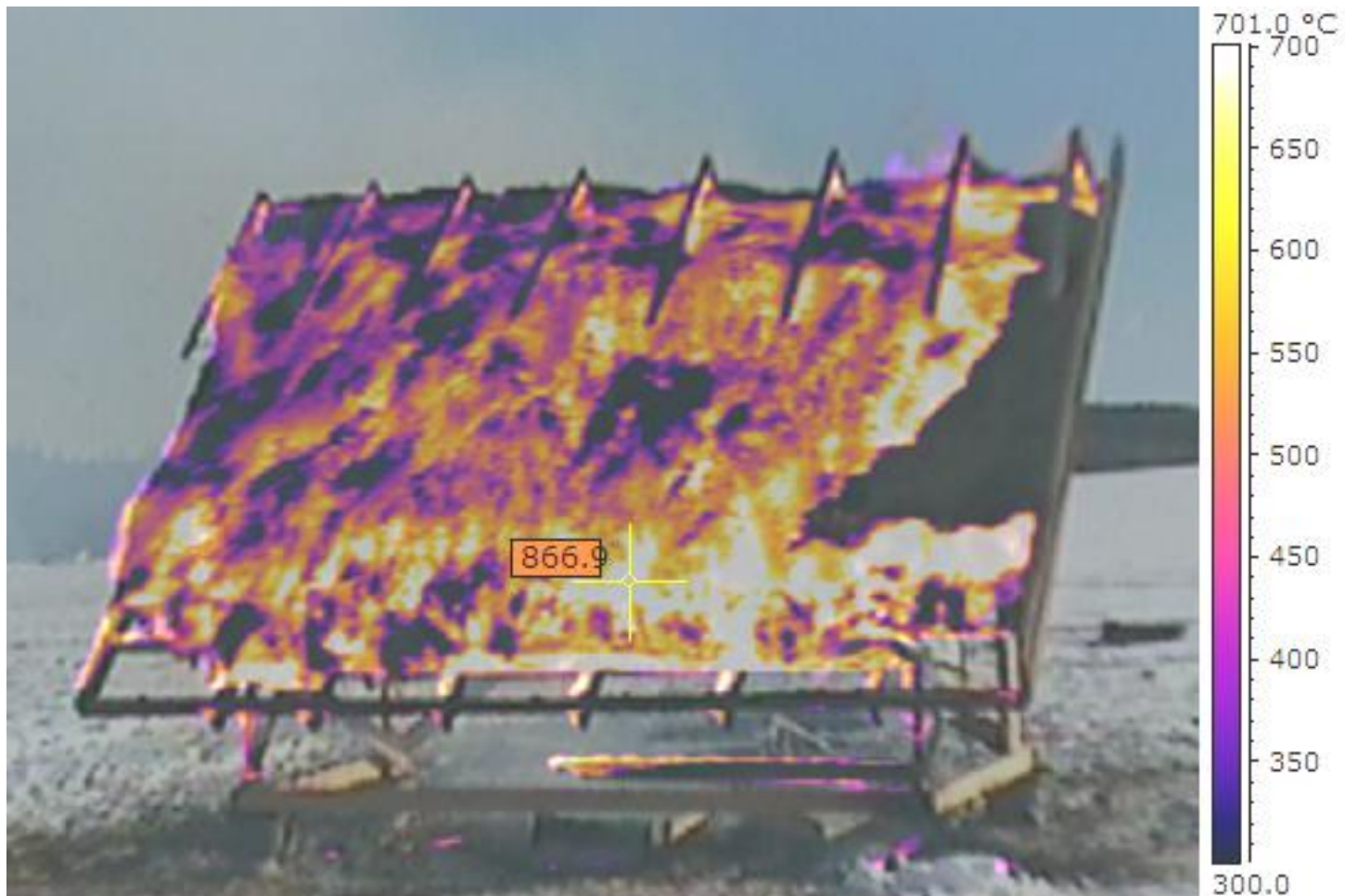

Figure 3.37. A thermal picture of roof 1, 22 minutes had passed from the lighting. Temperature on the eaves was >1000 °C

Extinguishing the fire

Since weather on the testing day was very windy, there were a couple of notable matters. Firstly, the infrared radiation was clearly observable below the wind and in 4 meters distance from the fire, even though the flames were relatively small. However, it was easily possible to stand there watching the fire

heavy blasts of wind. The re-lighting of the already extinguished roof parts made the fire fighting hard. As a consequence, when extinguishing a burning reed thatched roof, it is important to draw the burning matter and, if possible, also the unburned reed stalks down and away from the building with a rake or other tool. The flammable matter must be urgently got down from the roof, but on the other hand paying attention to the flammability of the environment surrounding the building is also essential. On the testing day, the snowy field would have been a safe envi-

ronment, but the reed was not pulled down from the roof.

The water spout coming with a high pressure often causes extra damage to the structures by breaking and soaking them. Concerning this, a waterproof underlay that slows down the burning is an effective barrier for water and can also save the interiors. Substructures like insulation wool layer, rafters and inner cladding get easily damaged when getting wet.

Findings and conclusion

Wind affects the spreading and the oxygen gain of the fire remarkably. During blasts the flames grew and the fire spread to the wind's direction. A thick layer of reed smothers the fire and tight substructures slow down the spreading of the fire in the roofing and to the interiors. In turn, wind strengthens the fire and heat and makes the latter to move deeper in the reed layer. This was detectable in this test also, for the tightest layer of reed was burning the most slowly. It is important to pay attention to the quality of the thatching work, because a tight layer of reed roofing keeps both the rainwater away and the flames low.

Concerning the tightness and waterproofness of the roof, two types of structures can be introduced: a ventilated and a non-ventilated roof structure. The first dries up faster after getting moist or wet because of a ventilation cap below the reed layer where the moisture can evaporate. Water vapour passes reed well so the moisture is able to evaporate in the ventilation cap or to the air outside also. However, in the event of a fire, the ventilation cap works like a duct, transporting oxygen and heat and thus speeding up the fire. A non-ventilated roof structure is better what comes to fire safety, because the burning reed layer does not get oxygen from below. Choosing a structure type is thus a two-sided matter: whether to favour fire safety or better endurance towards moisture.

A lot of attention should also be paid to details, for the fire could break through the weakest points. This was noticed also in the test: the fiberglass cloth of the roof #3 was incomplete on the up and down eaves and that was where the fire first broke through.

All test roofs should have had a wall structure protecting the frame, for example a timber facing of 28 mm or a fire gypsum board of 15 mm. With no walls, the wind rapidly blew the flames under the eaves, and the fire spread to the fascia, rafting and the frame structure. Roof No 2 was probably the fastest to suffer from this. In the beginning, the construction paper on down part of the structure was burnt and as a result, part of the eco wool panels fell down. The insulation does not matter much in this kind of an open roof structure, but in residential buildings, external fire and heat radiation to the interiors stifles due the insulation.

Overall, more attention should be paid to finishing the details of the thatched roofs built in the future. Eaves, ridge structures and other possible fringes are more sensitive to be lit and spread the fire than the middle edge, which should be considered already in the planning process. There are fire-safe methods documented in the new Finnish building instruction card of thatched roofs. An open eave is beautiful when the reed is visible from down, but it is not the safest option what comes to fire issues. The eaves can be protected with fire boards or fire insulation boards which can be hidden behind the eave boarding for they are not very pretty. Eaves can also be treated with flame retardant. A sealed eave boarding is also one option if the boards are thick enough. The charring speed of wood is approximately 0,8 mm per minute, which means that a fire endurance of 15 minutes can be achieved with a 12 mm thick board. Considering a standard fire of over 20 minutes, 7 mm should be attached to thickness. A 31 mm thick board provides a fire endurance of 30 minutes.

3.9. Thatched Roof as an Insulation Layer

Karel Lilleste, Meeli Kams, EULS Department of Rural Building

Buildings with thatched roofs are a defining characteristic of manmade landscapes in western Estonia and the islands. Thatched roofs can be either gabled roofs or hip roofs. Thatched roofs with a 45° slope define the overall appearance of the entire building. The roof can sometimes be twice as high as the external walls, meaning that there is a relatively high attic area under the roof, which has good insulating properties. Historically, the area under the thatched roof was ventilated, either through slits in the eaves, or in the case of hip roofs, triangular openings. In old days, people didn't care much about insulation. Today, with tourism developing, farms have started building attics into visitors' quarters, which of course must be warm and cosy. This led us to the idea of studying the extent to which the thatched roof effect increases when the slits and triangular holes are sealed (Figure 3.42) and how this affects the hydro-thermal state of the attic. The objectives were as follows:

- 1) studying the changes of the interior climate in the attic after the ventilation slits and triangular openings are sealed;
- 2) calculating the specific heat conductivity of thatched roofs;
- 3) calculating the temperature of the air in the attic which leads to icicle formation on the eaves.

The investigations were carried out on eight houses with thatched roofs (Söber 2013), which were located on the islands in West Estonia. Two of the houses were on Hiiumaa (Lilleste 2012), four on Muhu and two were on Saaremaa. The main investigations on Hiiumaa were conducted from 7 December 2011 to 15 April 2012 [2], but the temperature and humidity loads in the attics were also measured in the summer months. The measurements in the houses on Saaremaa and Muhu took place from 1st November 2012 to 25th April 2013. To conduct the experiments, the gaps under the eaves were sealed in the houses in which they were open and the gable ends were insulated. In some cases the extra correctly insulated

stud wall was erected to separate the attic space above a cold part of a house from the attic space above a heated part of the house. To characterise investigated houses better, the cross-sections of all the buildings and the plans of the attic's floors were drawn, and the houses were also photographed (Figure 3.38, Figure 3.39, Figure 3.40).



Figure 3.38. Farms studied. Upper: thatched roof with ridge covered with aspen boards and lower: the hip roof with venny holes and traditionally reinforced ridge (Photos: S. Söber)

Cross-section A - A

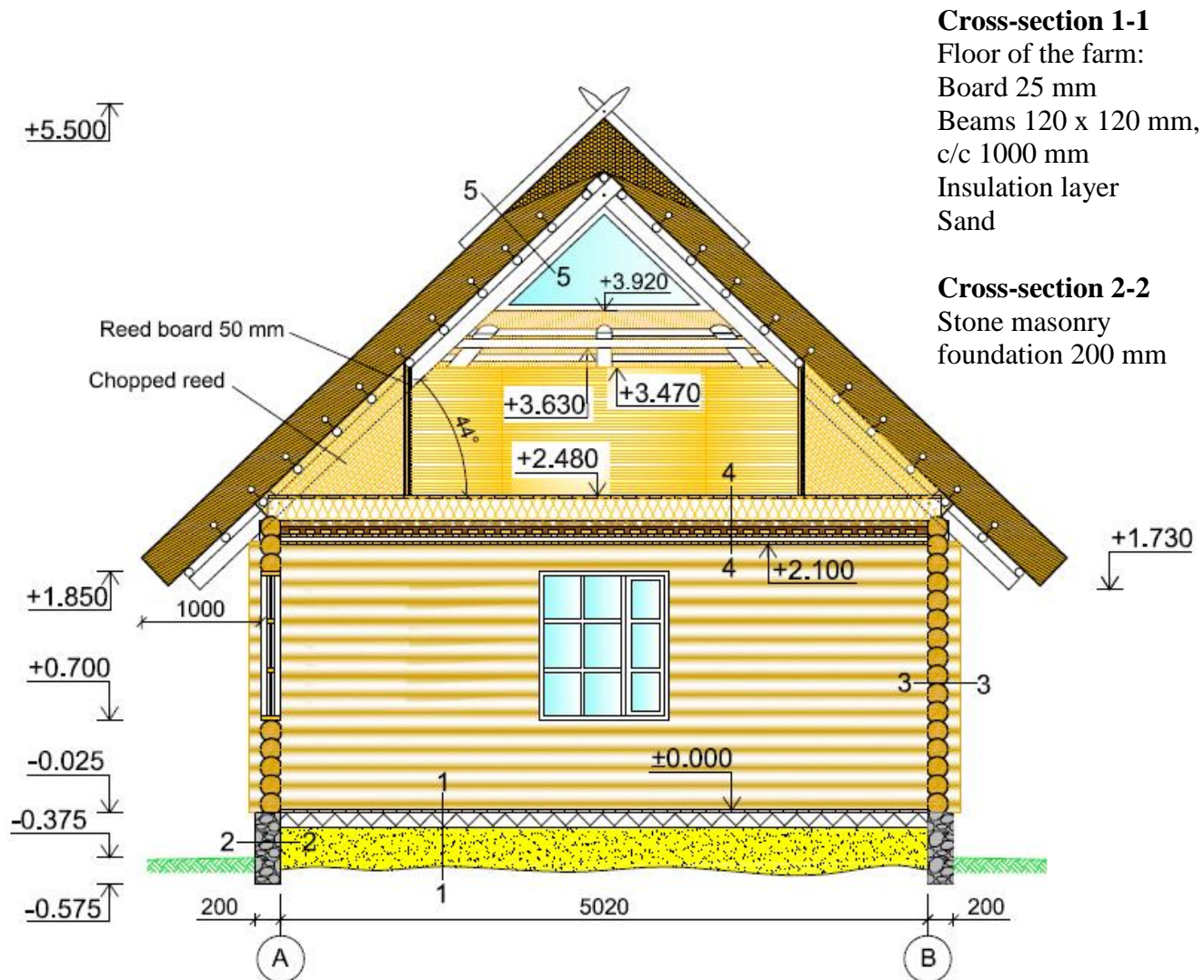

Cross-section 1-1

Floor of the farm:
Board 25 mm
Beams 120 x 120 mm,
c/c 1000 mm
Insulation layer
Sand

Cross-section 2-2

Stone masonry
foundation 200 mm

Cross-section 3-3

Outer wall of the farm
D shape logs 170 mm

Cross-section 4-4

Floor of the attic
Boards 25 mm
Beams 170 x 150 mm, c/c 600 mm
Rock-wool insulation 170 mm
Beams 170 x 170 mm, c/c 1600 mm
Termolite insulation 50 mm
Sand clay mix 30 mm
Boards 25 mm
Laths 40 x 40 mm
Siding 25 mm

Cross-section 5-5

Roof
Ridge sticks, d = 80
mm, c/c 400 mm
Cross-members
Battens d = 70 mm, c/c
370 mm

Figure 3.39. Cross-section of an investigated farm on Hiiumaa (Lilleste 2013 b)

Cross-section of attic's floor (+2.480)

- Floorboard 25 mm
- Beams 170 x 50 mm, c/c 600 mm, rock wool 170 mm
- Beams 170 x 170 mm, c/c 1600 mm
- 1) termolite ~ 50 mm
- 2) clay slurry 30 mm
- 3) board-on-board siding 25 + 25 mm
- 4) laths 40 x 50 mm
- Siding 25 mm

Cross-section of attic's floor (+2.660):

- Floorboard 25 mm
- Beams 100 x 50 mm, c/c 600 mm, rock wool 100 mm
- Board-on-board siding 25 + 25 mm
- Beams Ø 220 mm, c/c 1600 mm

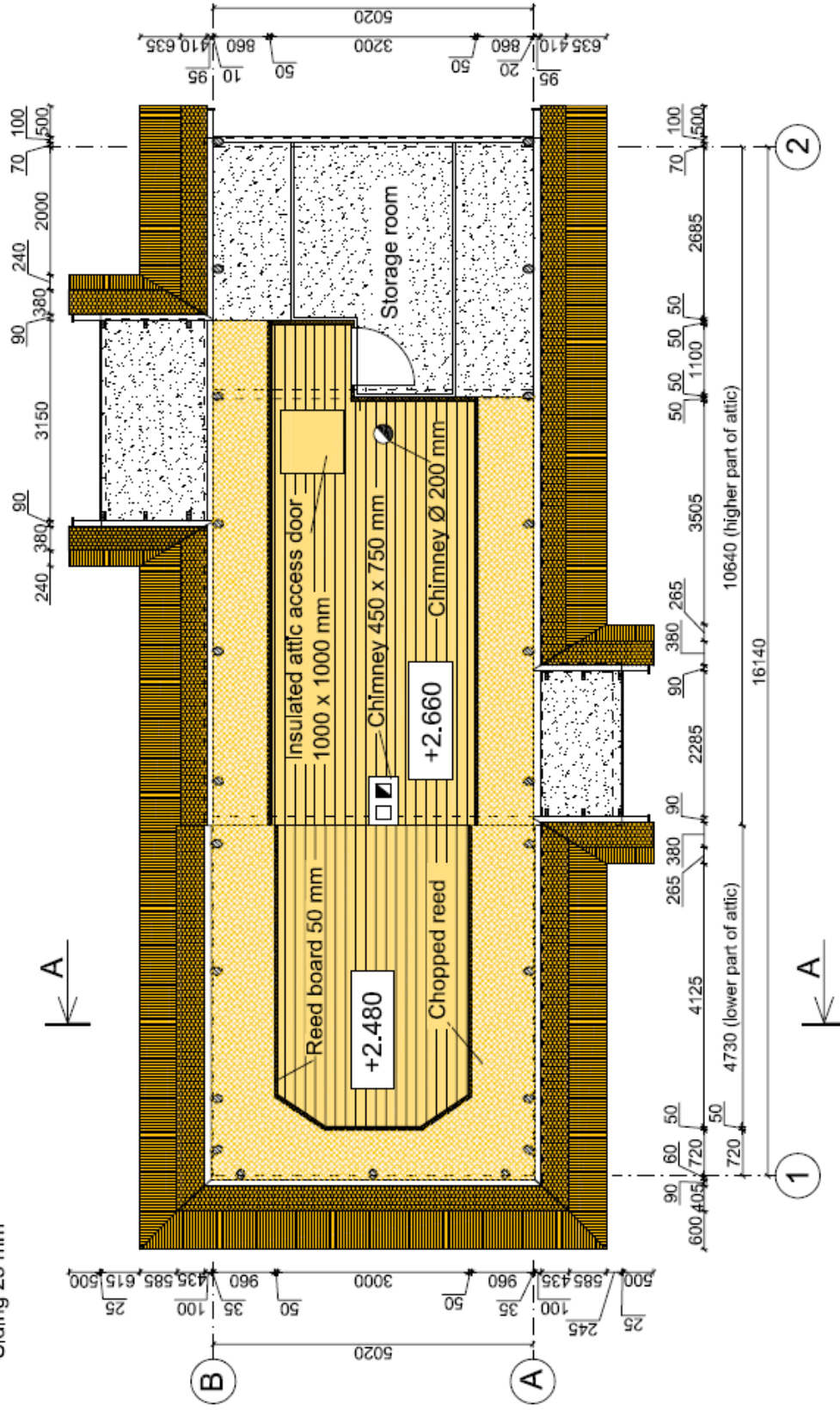

Figure 3.40. Plan of the attic floor of the farm on Hiiumaa (Lilleste 2013 b)

Air temperature (Figure 3.41) and relative humidity content (Figure 3.42) in the attics were measured in summer- and in wintertime. Both measurements showed that in spite of the reduced movement of air

and the rise of the average temperature (Figure 3.43) because of sealed eaves' gaps, (Lilleste 2012, 2013 b) the conditions in the attic didn't change suitable for mould growth.

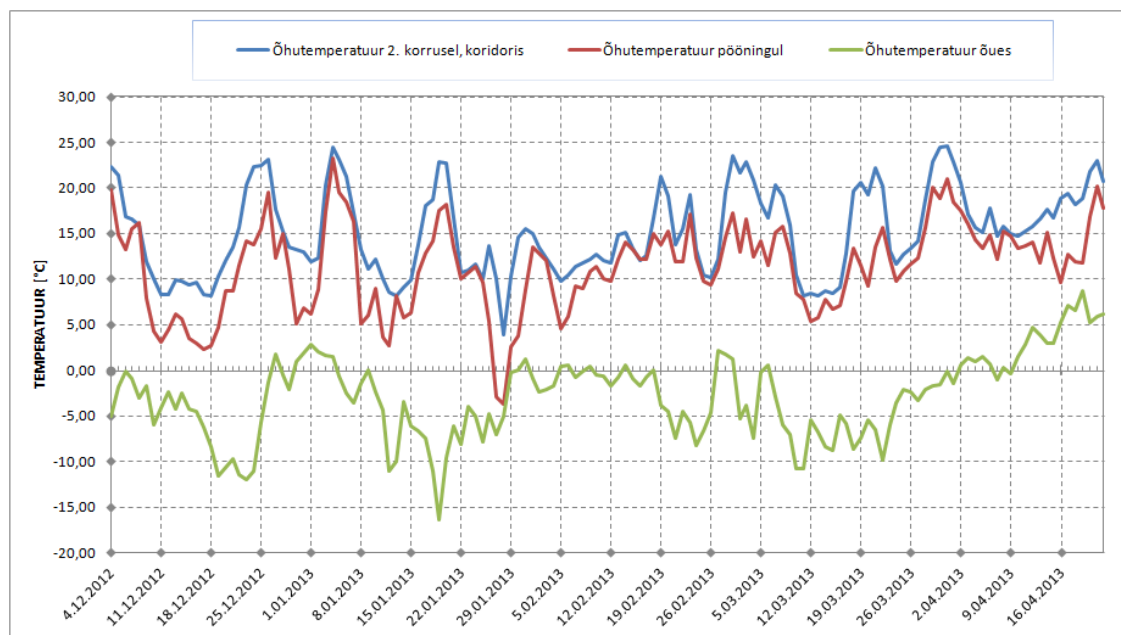

Figure 3.41. Graph of measured air temperatures (outside temperature: green line; inside temperature: blue line; temperature in attic: red line)

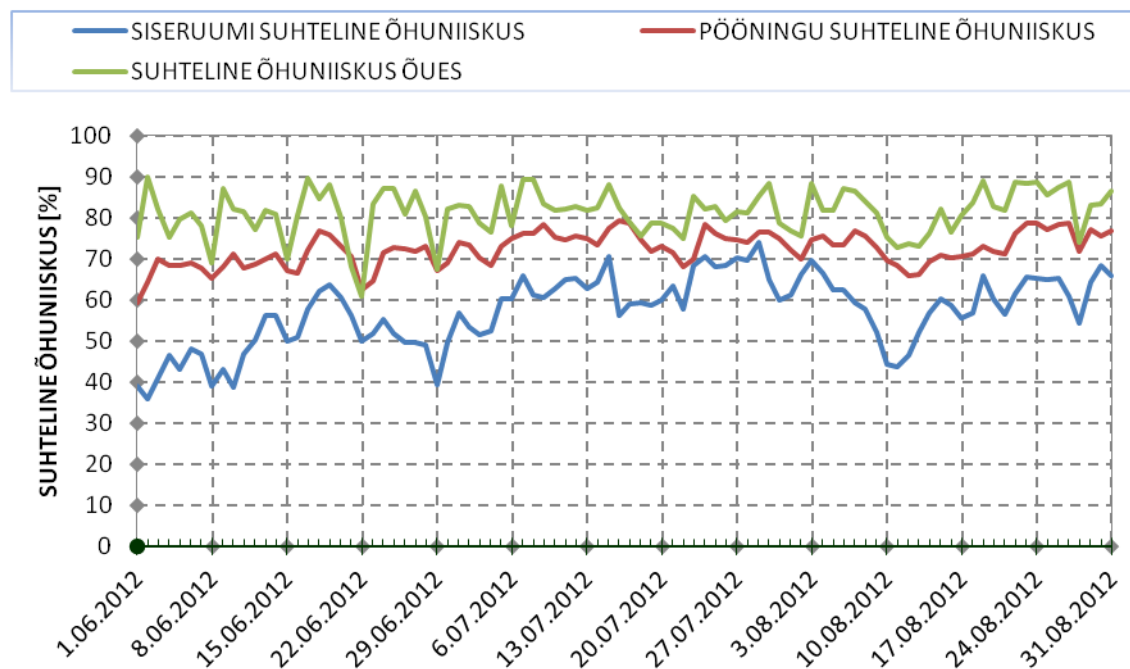

Figure 3.42. Graph of measured RH content: RH outside: green line; RH inside: blue line; RH in the attic: red line

The temperatures in the summer months ranged from 11-20 °C and the relative humidity was at the same time between 60-72%, the average temperature in winter ranged from 0-14 °C but the relative humidity content was the greatest (78%) in 0 °C and the lowest (42%) in 14 °C.



Figure 3.43. Properly insulated attic (Photo: S. Söber)

As most mould spores need over 70% relative humidity (RH) near the substrate for growth (the optimal RH is 90–100%) with a temperature of 20-30 °C (Hiss Reet 2013) then we can see from graphs that there was no danger of the biodegradation of organic substances either.

To control the situation the samples for determining the moisture content of the substrate were taken twice during the experiment from the underside of the roof in all houses. The moisture content was determined to be 8.6-14%, which was under the level appropriate for mould growth. (Söber 2013)

During the heating period, the temperatures on Laasu farm's attic were measured before and after the gaps under the eaves were closed, additional insulation and the construction of the extra stud-wall was done. As a result of the additional insulation, the attic air temperature rose by 1.7 °C (Lilleste 2013) and due to this the heat loss through the ceiling into the attic decreased and so the heating expenses reduced. Reduce in heating expenses occurred here only because of the better use of the existing thatched roof.



Figure 3.44. Icicles on the eaves of thatched roof (Photo: S. Söber)

As a result of the multi-year study, the heat conductivity of a thatched roof was calculated (Masso 2012, Reinpuu 2006) to be $\lambda = 0.18 \text{ W/m}^\circ\text{C}$ on a roof without snow (Lilleste a 2013), considering the amount of heat transferred by both convection and conduction. (Lilleste b 2013)

As the investigations were carried out on one farm where large icicles (Figure 3.44) formed on the eaves because the air temperature on the attic was high and the ceiling was poorly and unevenly insulated, there was interest in calculating the maximum temperature of the attic air with no icicles forming. The calculations showed that if the average air temperature in the attic of a thatched roof building is +11.4 °C, the uncompact snow on the roof would start to melt when the outside air temperature is -4 to -5 °C. Lightly compacted snow will melt when it is -2 to -3 °C and dense snow will melt when the temperature is > -1 °C. The highest 24-hour average air temperature in the attic measured was +23.2 °C in and in this case uncompact snow could melt even if the temperature outside is -8 to -9 °C (Lilleste 2013).

All measurements on objects were done using Almemo data recorder and HOBO Data Loggers:

HOBO U12 Temperature/Relative Humidity Data Logger. (Almemo 2005, Onset HOBO 2013)

References

Almemo®Manual. For all Almemo® measuring instruments up to version 6. 5th revised edition. Holzkirchen, 2005.

Hiss Reet. Growth of microorganisms on thatched roofs. [<http://www.hiss-reet.com/constructions-with-reed/thatched-roof/thatched-roof-architecture/microorganisms-on-thatched-roofs.html>] (15.06.2013)

Lilleste, K. a Hydro-thermal State of an Attic of a Thatched House. Master thesis in rural construction. Tartu: Estonian University of Life Sciences, 2012. 125 pp. (in Estonian)

Lilleste, K. b Report of hydro-thermal state measurements results in Tartu K. Kraavikalda 8 (A part of the Cofreen project.) 2013. (in Estonian)

Lilleste, K. c Hydro-thermal state and air exchange in attics of thatched roof dwellings on the islands in West-Estonia (Report done as a part of Cofreen project) Not published, Tartu: University of Life Sciences, 2013. (in Estonian)

Masso, T. Handbook for structural engineers. Tallinn: Ehitame 2012. 577 pp. (in Estonian)

Onset: HOBO Data Loggers. HOBO U12 Temperature/Relative Humidity Data Logger. [<http://www.onsetcomp.com/products/data-loggers/>] (22.05.2013)

Reinpuu, R. Construction Physics Tallinn: Tallinn University of Applied Sciences, 2006. 46 pp. (in Estonian)

Sõber, S. Hydro-thermal State and Air Convection of attics in dwellings with thatched roofs. Master thesis in rural construction. Tartu: Estonian University of Life Sciences, 2013. 90 pp. (in Estonian)



Some pictures of investigated dwelling houses (Photos: S. Sõber)

3.10 Light Clay-reed Blocks

Kristina Akermann, EULS

For more efficient use of reed waste, it can be used to make light clay blocks. Clay buildings constructed many years ago are still standing today, if their roofs had remained intact. Thus it can be said that a clay building lasts for a long time. A drawback of a clay building is specifically poor thermal resistance. In order to improve this, traditionally clay was mixed mostly with straw.

In the Estonian University of Life Sciences experiments were carried out with light-clay blocks in the framework of Interreg IV A project Cofreen. Test samples with different density were made of reed and clay, the compressive strength and thermal conductivity of which was then measured. Compressive strength was measured based on a method described in the standard EVS-EN 826:1999

and the tests were carried out with test equipment П-125. The thermal conductivity test was carried out in a Feutron 3007-5 climate chamber using a heat flux measuring plate and Almemo data logger. The results are presented in Table 3.7.

With test samples made of natural materials it is not easy to achieve homogeneity and the density of the test samples differed even if the volume composition of samples is the same. However, Table 3.7 shows that the compression strength is the worst in test sample CRB-3, where the clay and reed chips ratio was 1:4, and best in those blocks where the reed was mixed with flax chips.

Most probably the finer particles of flax chips (compared to bigger and more slippery pieces of reed chips) bonded more strongly with the clay and thus also the compressive strength of the block was bigger.

Table 3.7 shows that although the compressive strength of blocks with different ratio of ingredients

Table 3.7 Thermal conductivity and compressive strength of light clay-reed blocks depending on density of block

| Block no. | Ratio of ingredients; clay, reed, flax chips | Density, 1 kg/m ³ | Compressive strength, N/mm ² | Density, 2 kg/m ³ | Heat conductivity, W/mK |
|-----------|--|------------------------------|---|------------------------------|-------------------------|
| CRB-1 | 1:2:0 | 788 | 0.4 | 690 | 0.125 |
| CRB-2 | 1:3:0 | 605 | 0.4 | 486 | 0.102 |
| CRB-3 | 1:4:0 | 558 | 0.3 | 425 | 0.112 |
| CRB-4 | 1:1:2 | 651 | 0.5 | 561 | 0.124 |
| CRB-5 | 1:2:2 | 699 | 0.5 | 612 | 0.117 |

differs notably, varying in the range of 0.3-0.5 N/mm², variations within thermal conductivity are much smaller and thus it can be said that there is no relation between the density of a block and thermal conductivity. As the number of tested blocks was rather small, it is not possible to make statistically trustworthy conclusions; and further tests should be carried out. At the same time, it is a fact that the thermal conductivity of all light clay-reed blocks was in the range of 0.102-0.125 W/mK.

When using light clay blocks it should be considered that porous material is not air tight and thus when using these blocks the air tightness of the wall must

be achieved in some other way, for instance by plastering. (Akermann, K. The mechanical and thermal insulation properties of light clay blocks. Compendium of scientific studies of Estonian University of Life Sciences 2012, Local natural building materials and their use. Tartu pp 15-26, in Estonian)

Reed as a thatching and heat insulation material is certainly worth considering when building a house. In many countries, including Estonia, guidelines for building houses with thatched roofs have been developed.

4. Reed as a Renewable Energy Source, Equipment and Technologies for Using Reed in Energy Industry

Ülo Kask, Livia Kask, TUT

Availability of reed resources, human and natural factors

Conditions for reed growth

Densities, biomass and morphological characteristics of reeds depend on habitat conditions determined by the latitude, e.g. climate and light conditions, salinity, water depth, trophic conditions and interactions between these factors. These often changing habitat conditions may cause large yearly fluctuations in biomass (Iital et al., 2012).

The structure of reed-beds and composition of its species along the transect from the sea to the coast changes. Reed can grow only in shallow waters (< 1.0 m) and reed-dominated communities prevail usually in water depths below 0.3 meters (Roostike..., 2008).

Reed grows on most soil types from fine clays to sandy loams, but it prefers soil with high organic matter content. It is quite tolerant to pH of the soil that can vary from 3.6 to 8.6, but usually the pH should be 5.5-7.5 (Roosaluste, 2007). Thus the occurrence of reed indicates slightly acid and nitrogen-rich conditions. The reed is also rather salt tolerant with the optimum varying from 0 to 15 psu – (practical salinity unit) (Huhta, 2007). Thus the reed will find suitable conditions both in fresh waters as well as in brackish waters. Several studies have demonstrated the negative effect of increasing salinity on density, height, stem diameter, biomass and rhizome reserves of reed (Iital et al., 2012).

Availability of nutrients, particularly nitrogen and high soil fertility will usually increase the number, height and weight of shoots. The rising trophic level that increases the thickness and length of shoots makes them also rather weak against environmental disturbance or for some particular uses (e.g. for thatching). Lots of nutrients are stored in rhizomes in

summer and winter those facilitate rapid growth in spring, independent of photosynthesis. The colonization into new areas can be affected also by waves, environmental disturbance, nutrient availability and competition with other species (Iital et al., 2012).

Reed biomass productivity

Reed is amongst the most productive plant species in the Baltic Sea Region due to its high bio-production per unit of wetland area. The biomass from reed depends on the age and structure of reed as well as on the water level and presence and abundance of other vegetation conditions that can vary considerably (Räikkönen, 2007). Especially excess nutrients can considerably increase the productivity of reed. The maximum seasonal shoot biomass generally increases from north to south (Brix et al., 2001). A reed bed may contain up to 200 - 300 stands per m², but the average density can be much lower (Roosaluste, 2007) depending on the local conditions. The quality of reed and its biomass also varies significantly from a dry reed bed in terrestrial areas, which is largely mixed with other vegetation to pure reed stands in water (Räikkönen, 2007). This aspect should be considered also when planning to take the reed into use.

The amount of below-ground reed biomass (roots, rhizomes) is usually larger than that of above-ground, and only a part of it is the current year's production (Fiala, 1976; Szczepahska, 1976). Reed produces the above-ground biomass typically around 1000 g dry weight per m², but the reported values extend to the levels as high as 7700 g dry weight per m² (Soetaert et al., 2004), being much lower in the northern part of Europe. The results of EUREED II project showed that the maximum seasonal biomass of reed shoots can grow only 300-400 g/m² in the northern part of the Baltic Sea area (Brix et al., 2001). As a matter of fact the annual net above-ground reed production is about 3–15% higher than the maximum biomass because of shoot mortality, leaf shedding and grazing during the growth period (Iital et al., 2012).

The measured average summer yield of reed by dry matter in Estonia in the period of 2006-2011 was 9.14 t/ha and that of winter reed 7.36 t/ha. The summer yield of reed was 24.5% higher than winter yield due to loss of leaf mass (Ü. Kask, unpublished). The biomass of winter harvested dry (moisture content 16.2-19.3 %) reed in the Curonian Lagoon (Lithuania) varies from 5 to 40 t/ha depending on the location and nutrient inputs to the water system (Balevičiene et al., 2007). In Niedermoor (Germany) the average biomass is 12.5 t/ha but can be more than 20 t/ha in some locations and in different years (Wichtmann and Wichtmann, 2009). Average biomass yield varies strongly also in other wetlands in Germany depending on the location and the local conditions (Timmermann, 2003). The results of the study from Hirvensalo and Salo areas in Finland revealed that the mean biomass of dry reed is between 5-7 t/ha and can reach up to 12 t/ha (Räikkönen, 2007). Quite similar yield levels (4.6-7.4 t/ha of dry matter) were obtained by Isotalo et al. (1981). The relatively rather high yields suggest that probably the residues from some earlier vegetation periods could be included (personal comment by W. Wichtmann). The maximum seasonal biomass of living rhizomes of *Phragmites communis* is usually much higher compared to the above-ground biomass varying from about 3000 to 11,000 g of dry matter per m² and may reach 16,800 g dry weight per m². The northern populations have greater rhizome-to-shoot ratio compared to the southern populations of reed (Brix et al., 2001).

Reed beds in Baltic Sea region

Reed can be found in many coastal areas of the Baltic Sea, growing at the interface between the marine and terrestrial environments where there are favourable conditions for the plants. The spatial distribution of reed is difficult to estimate since not all countries carry out annual inventories of reed beds (areas) and the amount of biomass growing in the beds. The area of reed beds is quite variable and can change a lot during a year depending on the natural expansion rate, ice conditions during winter, changes in grazing practices and reed cutting. It is very problematic how to set the boundaries between marine and terrestrial environments. The reed bed areas have expanded very rapidly in some parts of the Baltic Sea Region

over past 10 years. A rough inventory, which may partially, also include reed beds in coastal lakes, estimates that the total area of reed in the Baltic Sea exceeds 300 000 ha. The largest resources in Sweden are over 230 000 ha, in Estonia approximately 20 000 ha (Iital et al., 2012). For example, it is estimated that the areas covered by mono-dominant stands of Common reed reach as much as 200,000 ha in the Danube delta (Rodewald-Rodescu, 1974).

The colonization of reed into new areas can be affected by waves and ice conditions, environmental disturbance e.g. drought and frost, grazing and mowing, nutrient availability and competition with other species (Roosaluste, 2007). Regular livestock grazing can suppress the reed growth and therefore, reed-bed areas at some coasts are on the wane. Reshaping of coastal areas through grazing is a favoured process in Germany, for example (<http://www.hiss-reet.com>). Dying back of reed in many parts of Europe due to the different man-induced environmental changes in the last decades has been reported (Van der Putten, 1997; Brix, 1999) and by many other authors. The decreased use, including mowing and grazing in several coastal areas in Europe (as in Estonia), have led to the expansion of the Common reed areas (Pitkänen et al., 2007). This process is probably faster due to the increased mean air temperature. Many of the wetlands in the Baltic Sea Area are designated as nature reserves that probably also diminished the utilization of reed. In these areas in order to make economic use of reed a special authorization may be required. Therefore, the reed can be found also in many areas along the coasts of the Baltic Sea where it grows on the interface between the marine and terrestrial environments (Pitkänen et al., 2007).

The total aboveground biomass of reed along the coasts of the Baltic Sea is about 0.45-1.5 million tonnes assuming that the mean annual biomass of common reed that potentially can be used is 3 to 10 tonnes per ha. About two-thirds of the resource is located in Sweden assuming that the provided reed-bed area involves only the coastal reed-beds. Not all of the annual yield can be harvested, partly due to the environmental restrictions. Therefore, the total annually usable resource form not more than one third of the total above-ground biomass in the Baltic Sea that is approximately up to 0.5 million tonnes. The share

of annually usable reed resource can be much lower (15-20%) in protected coastal areas (Roostike..., 2008).

There are several factors favouring the use of reed in the Baltic Sea region, including large coastal areas with reed beds, long history of use, cold winters that allow harvesting on ice, adopted policies for substitution of fossil fuels in the energy basket, many study results and availability of trained and skilled labour. The moisture content of winter reed is low that makes it suitable for energy production and reduces the expenses for drying. Therefore, the reed areas available for energy production can be quite remarkable ranging, for example, in Estonia from 3,500 to 7,000 hectares annually (Holmberg, 2009) depending on the harvesting methods, environmental restrictions and the economic viability of reed. Reed cannot be harvested in the same location every year and thus the annually harvested area needs to be significantly smaller than the total area in use for energy purposes.

In all countries in the BSR water protection and treatment of waste water by using unconventional methods, including wetland systems, have been considered as an important environmental goal. Therefore, rather large coastal reed-bed areas provide a good opportunity for post-treatment of wastewaters discharged to the sea after conventional treatment.

Quite large reed-beds of the Baltic coasts are probably located in protected areas including the Natura 2000 sites that could restrict the use of resource for specific purposes. The main goal in these areas is to maintain the environmental service provided by the reed and reed-beds. For example, about 4000 ha of reed-beds in the western archipelago of Estonia is located in nature conservation areas where the protection of species is a priority and winter harvesting of reed is strictly regulated (Roostike..., 2008).

Reed fuel and its properties (moisture, ash, calorific value, elemental composition, etc.)

Common reed has been used for different purposes since ancient times. These uses include thatching the roofs, covering the walls of houses with reed, fodder for cattle, etc. Nevertheless, the need for reed as a resource diminished remarkably over the past centu-

ries. Rather new uses of reed, such as biomass fuel and biogas production, a raw material in cellulose production or post-treatment of wastewater has led to the situation when different beneficial uses for Common reed has been accounted as one of the nowadays information gaps (Meyerson et al., 2009).

Biomass is one of the most important renewable energy sources in the world. The demand for energetic utilization of biomass is increasing enormously and often supported by governmental regulations. Common reed can also be accounted as a promising biomass source (Holmberg, 2009). Reed can be used as a solid biofuel for direct combustion as well as transformed to a liquid biofuel (bioethanol) and gaseous biofuel (biogas, biomethane).

However, the properties of reed as a potential fuel have to be investigated, because the way of handling reed for burning, lifetime of combustion technology (fouling, corrosion), combustion regimes and environmental impact (emissions) depend on these properties. The reed combustion characteristics vary to some extent depending both on the site of growth (on the shore of sea or lake, river deltas, wetland treatment systems) and seasonally (harvested either in summer or winter). The most significant combustion characteristics are moisture content, calorific value, content of volatile matter, ash content and its composition.

Moisture

High moisture content reduces the heating value of fuel, increases the volume of flue gases, and deteriorates ignition and combustion. The moisture content of energy reed changes significantly over the year (Figure 5.1). The best quality reed for using as a fuel, with respect to moisture content 18–20 %, can be harvested from January to March in Estonia, over a period of around 90 days a year. The relative moisture content of summer (July-August) harvested reed is from 56% up to 69% (mostly in July); two year (2006-2007) average is ~60% (by studies of TUT DTE).

The relative moisture of reed matter as received can be calculated by the formula:

$$W' = \frac{M - M_1}{M} \times 100\% ,$$

M – wet reed mass (reed as received), kg,

M₁ – dry reed mass, kg.

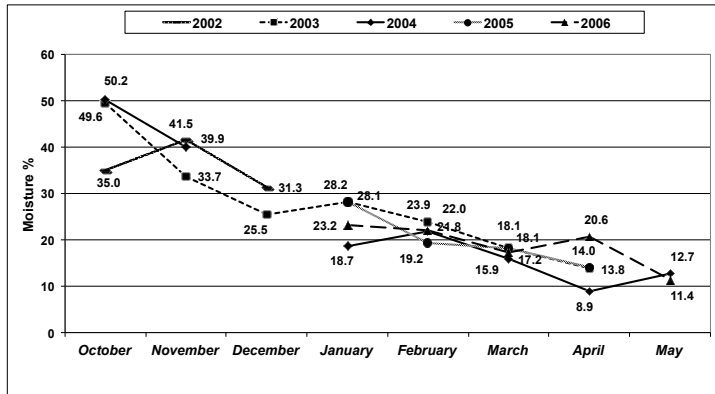

Figure 4.1. Moisture content of reed harvested between October and May (2002-2006; TUT TDE) (Kask et al., 2007)



Figure 4.2. Reed fuel (height of reed stalks 5-10 cm) (Photo: Ü. Kask)

Calorific value

Reed has the calorific value comparable to other plant species and solid biofuels (Table 4.1). The calorific value of reed fuel is mainly determined by the moisture content and is shown on Figure 4.1. It depends much on the growing or harvesting period.

Table 4.1. Calorific value (dry matter) and energy content of Common reed in comparison with other fuels (Alakangas, 2000)

| Fuel (fuel feedstock), dry matter | Net calorific value, MJ/kg | Energy content, MWh/t |
|-----------------------------------|----------------------------|---------------------------|
| Hard coal | 28,2 | 7.8 |
| Heavy fuel oil | 40.6 | 11.3 |
| Natural gas | 33.5 MJ/m ³ | - |
| Pine wood | 19,5 | 4.15 (air dry) |
| Cutting residues (mix) | 19.4 | 2.4 (moisture 50%) |
| Grain straw | 17.4 | 3.75 (moisture 20%) |
| Reed Canary Grass | 17.6 (spring) | 3.9 (moisture 20%) |
| Hemp | 17.35 (spring) | 3.75 (moisture 20%) |
| Flax | 18,8 | 4.1 (moisture 10%) |
| Reed | 17.8 (winter) | 3.9 (moisture 20%) |

The calorific value of reed Q_b was determined in the calorimetric bomb (Table 4.2). In the table also the upper Q_u and lower Q_l calorific values (respectively gross and net calorific value) are given. When flue gas leaves the combustion unit at the temperature higher than the condensation temperature of water vapour, the lower heating value is used. In the engineering and economic calculations it is more convenient to use the volumetric energy density of moist fuel as received at 20% moisture content (E₂₀) kWh/kg, kWh/m³ or MWh/m³, MWh/t (last row in Table 4.2). The calorific value of dry matter depends on the amount of combustible matter and its chemical composition (Table 4.2).

Table 4.2. Calorific value of dry reed fuel, MJ/kg (TUT TDE)

| Parameters | Range | | Average | |
|-------------------|-------------|-------------|---------|--------|
| | Winter | Summer | Winter | Summer |
| q_b | 18.62–19.16 | 18.33–18.77 | 18.92 | 18.51 |
| $q_{gr, d}$ | 18.62–19.16 | 18.31–18.75 | 18.91 | 18.49 |
| $q_{net, d}$ | 17.48–18.01 | 17.02–17.44 | 17.77 | 17.21 |
| $q_{net, 20}^*$ | 13.68–14.86 | 13.16–13.49 | 14.17 | 13.31 |
| $E_{20, MWh/t}^*$ | 3.80–4.13 | 3.65–3.75 | 3.94 | 3.70 |

* at 20 % moisture content

The net calorific value of dry reed fuel is about 17.5–17.9 MJ/kg while that of the dry Common reed can range from 17.2 MJ/kg to 18 MJ/kg (Kask et al., 2007) that is similar to other plant species (McKendry, 2002 and Table 4.3). The comparison of energy content (heating value) of reed shoots, which is about 5 kWh kg⁻¹ of dry matter with an energy content of oil for heating purposes, which is about 12 kWh kg⁻¹, gives a quotient (oil/reed) of 2.4: 1 (Graneli, 1984).

Reed energy resources in Estonia

During the period 1996–2009 on the Estonian coastal area of the Baltic Sea the expansion of reed growing area (reed beds) has took place due to the increase of the habitat of common reed. The increment of growing area has been approximately 2.5 times during last 13 years, it means averagely 276 ha/y (Eesti riikliku ..., 2010).

A study (carried out in 2011) in six Estonian coastal counties (Table 4.3) revealed considerable differences in the primary energy content of summer

and winter harvested reed. The total primary energy content of the dry matter of winter reed is 575.6 GWh and energy content of reed as received is 463.8 GWh (at moisture content W=20% as typical during the harvesting period from January to April). The total primary energy content of biogas digested from summer harvested green reed silage is much lower, 206.6 GWh.

The total area of Estonian reed beds is estimated ~26 000 ha according to the map of wetlands of Tartu University Department of Geography (Kütuse ja ..., 2002). By investigations carried out in 2007 the total area of all Estonian reed beds (including lakes) is 27 746 ha (according to the data of the Estonian basic map, air photos and Corine map) (Kask & Kask, 2013). The biggest reed beds in Estonia cover almost 3 000 ha in the Matsalu Wetland where reed is dominating over other plants while the reed beds there are among the largest in Europe. The Mullutu bay and Suurlaht (so-called internal sea or former bays with a free connection to the open sea) reed growing areas in Saaremaa cover about 2 200 ha (Kask et al., 2007).

Table 4.3. Theoretical primary energy content of Estonian coastal reed beds (by Ü. Kask, TUT DTE)

| County | Area of reed beds | Average yield in 2006-2011 | | Primary energy content | | Primary energy content at W=20% |
|----------------|-------------------|----------------------------|------------------------|------------------------|---------------------|---------------------------------|
| | | Winter | Summer | Winter ¹ | Summer ² | Winter |
| | ha | Y _{DM} , t/ha | Y _{FM} , t/ha | DM, GWh | FM, GWh | GWh |
| Lääne-Viru | 379 | 8.45 | 25.61 | 15.69 | 5.80 | 12.62 |
| Harju | 265 | 9.24 | 32.45 | 12.01 | 5.14 | 9.65 |
| Lääne | 8 000 | 4.96 | 16.81 | 193.65 | 80.37 | 156.34 |
| Hiiu | 2 685 | 8.36 | 18.55 | 110.01 | 29.76 | 88.44 |
| Saare | 7 387 | 4.62 | 14.01 | 167.24 | 61.85 | 134.46 |
| Pärnu | 1 343 | 11.77 | 28.27 | 76.98 | 22.67 | 62.28 |
| Total | 20 059 | - | - | 832 | 563 | 740,2 |
| Average | - | 7.9 | 22.62 | | | |

¹ – Calorific value of the dry matter of winter reed is 4.9 MWh/t and that of reed with the moisture content 20% 3.94 MWh/t.

² – Biogas yield of summer reed is 166 m³/tFM (fresh matter) and biogas calorific value is 6 MWh/1000 m³ (by studies of TUT DTE).

For providing sustainability of reed beds, it is not reasonable to cut reed in the same areas each year and harvesting in all the areas is also not practicable due to unfavourable environmental conditions and ownership relations. Based on the above and considering the areas of Estonian reed beds as a result of crop yield measurements in 11 counties, the really available reed resources, which could be used for energy production, would be approximately 300 GWh/y. The yearly harvestable area is about 13 000 ha (Kask et al., 2007). It has to be taken into account that besides the energy needs, reed is a suitable material for the construction and other purposes, which means competition between different requirements.

Reed elemental composition

The organic matter of fuel reed (OM) is mainly composed from carbon (C), oxygen (O) and hydrogen (H) similar to wood fuel (Vares et al., 2005)

but the oxygen content in the OM of reed as an annually regrowing plant is somewhat higher and those of carbon and hydrogen a bit lower. The content of nitrogen (N), sulphur (S) and chlorine (Cl) in the reed samples harvested in winter is low. The sulphur content of wood is usually below 0.05 %. The reed harvested in summer contains more nitrogen, sulphur and chlorine unfavourable for burning compared to the winter harvest (Table 4.4).

The ash content of reed harvested in winter is 2.1–4.4 %, in average 3.2 %, but for summer harvested reed it is significantly higher being 4.1–6.2 %, in average 5.4 %. The ash content of reed is higher than e.g. for wood (up to 2.0%, averagely 0.5-0.7%), but it does not cause major problems for combustion (Graneli, 1984), especially in larger boilers. The data on the chemical composition of reed ash is shown in the table and figure (Table 4.5 and Figure 4.3). The range means that samples from 14 different growing sites were analysed and each had different component content (Kask et al., 2007).

Table 4.4. Elemental composition of dry fuel reed, % (TUT DTE)

| Element | Range | | Average | |
|---------|-------------|-------------|---------|--------|
| | Winter | Summer | Winter | Summer |
| C | 46.96–48.34 | 46.13–47.11 | 47.5 | 46.5 |
| H | 5.50–5.60 | 5.93–6.42 | 5.6 | 6.2 |
| O | 42.75–43.84 | 39.7–42.2 | 43.3 | 40.7 |
| N | 0.23–0.34 | 0.57–1.17 | 0.3 | 1.0 |
| S | 0.03–0.09 | 0.12–0.45 | 0.04 | 0.2 |
| Cl | 0.05–0.18 | 0.28–0.48 | 0.1 | 0.4 |

Reed ash content and composition

Table 4.5. Chemical composition of reed ash at 550 °C, % (TUT DTE)

| Component | Limits | | Average | |
|--------------------------------|-------------|--------------|---------|--------|
| | Winter | Summer | Winter | Summer |
| SiO ₂ | 65.34–85.50 | 25.90–48.33 | 77.77 | 37.10 |
| Fe ₂ O ₃ | 0.13–0.84 | 0.17–1.69 | 0.29 | 0.70 |
| Al ₂ O ₃ | 0.1–1.69 | 0.11–1.12 | 0.57 | 0.61 |
| CaO | 3.07–7.27 | 4.02–11.53 | 4.42 | 6.84 |
| MgO | 0.4–1.45 | 1.87–4.88 | 1.22 | 3.33 |
| Na ₂ O | 1.96–9.05 | 0.87–10.98 | 3.19 | 3.61 |
| K ₂ O | 0.99–5.69 | 14.89–31.33 | 4.26 | 24.77 |
| Other | 1.57 – 19.4 | 17.28 – 33.5 | 8.28 | 23.04 |

The chemical composition of reed ash for summer and winter harvests differs essentially for the content of SiO₂ and K₂O. The reed harvested in winter would be a much better fuel to burn in the combustion equipment from the point of view of ash composition. The ash of reed harvested and dried in summer contains in significant amounts alkali metals that influence both ash fusibility, formation of ash deposits on the heating surfaces and metal corrosion (Kask et al., 2007).

The ENAS Oy in Jyväskylä has determined the element content of winter reed ash (Figure 4.3). The

microelements are considered the elements the content of which is agreed to be below 1000 mg/kg (however, usually below 100 mg/kg). The ash-fusibility temperatures depend both on elemental and component composition. Often the ash-fusibility temperature is treated as depending on the total of ash alkali components or ratio of alkali and acid components. The ash-fusibility temperature depends also on the test environment: in the reducing and semi-reducing environment the fusibility temperatures are generally lower than in the oxidizing atmospheric environment (Paist et al., 2007).

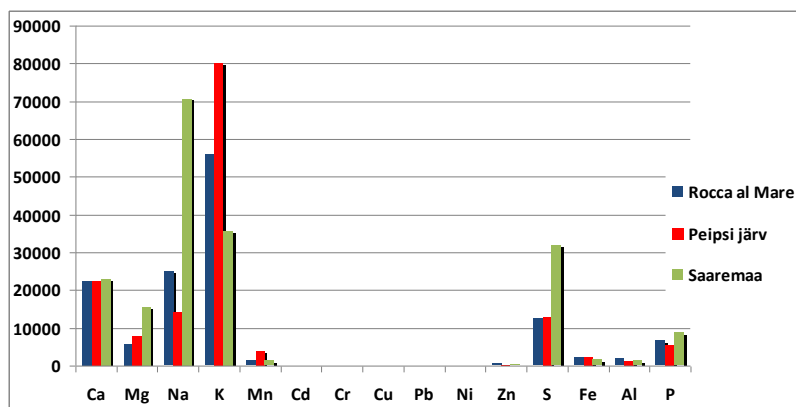

Figure 4.3. Element content in the winter reed ash, mg/kg (ENAS Oy)

Ash-fusibility (melting) temperatures

The winter and summer reed ash-fusibility temperatures of some samples are given in Table 4.6. It is essential to note that the summer reed ash cone fused down at the temperature lower than 1 200°C, initial deformation took place at temperatures below 800°C (Table 4.6). On the other hand, the ash of winter reed did not fuse down even at 1 330°C; only one sample showed some evidence of deformation at the temperature of only ~800°C. We can state that the average ash-fusibility temperatures for summer and winter reed ashes differ for 200 °C (Kask et al., 2007).

Chemical elements that affect ash-fusibility temperatures are Si, Ca, K and Na. That enables to consider the dependence of reed ash on these elements oxides

in the ternary diagram as well. The oxides of alkali metals K_2O and Na_2O , which have influence on the ash-fusibility temperature in combination with other chemical compounds bring down the ash-fusibility temperature in general (Paist et al., 2007). The content of alkali metals in the reed harvested in winter is essentially lower than that of summer reed and therefore the fusibility temperatures are also significantly higher. The correlation between the laboratory defined ash-fusibility temperatures and isotherms of ternary is quite good. The ash-fusibility temperatures of summer reed are significantly lower and therefore the danger of ash sintering and fusion by burning in the high-temperature flame is high. Also the danger of fouling heating surfaces with the ash particles and slagging grates is high. Thus the dried summer reed could be burned in a low-temperature furnace, but also in a bubbling fluidized bed furnace at the temperature about 850 °C. This proves that the reed as a boiler fuel must be most definitely harvested in winter when the nutrients and minerals have accumulated in the roots and leaves have fallen (Kask et al., 2007). The ashes formed during combustion soil the surface of the furnace, obstructing heat exchange and potentially accelerating high-temperature corrosion. The best-known components that accelerate corrosion are compounds of alkali metals, chlorine and sulphur (for example pyrosulfates). The content of alkali metals in winter harvested reed is lower than in summer harvested reed, which results in significantly higher fusibility temperatures of winter harvested reed (Kask et al., 2013).

Table 4.6. Reed ash fusibility characteristics (summer, winter 2006, TUT DTE)

| Fusibility characteristics of summer reed | | | | | | | | |
|---|------|------------------------|---------|---------|---------|---------|---------|---------|
| Samples of different sites | Unit | I 06 01 | I 06 02 | I 06 03 | I 06 04 | I 06 05 | I 06 06 | I 06 07 |
| Deformation temp DT | °C | 700 | 650 | 670 | 640 | 730 | 690 | 580 |
| Shrinkage temp ST | °C | 990 | 1000 | 1040 | 960 | 1030 | 910 | 760 |
| Hemisphere temp HT | °C | 1130 | 1110 | 1120 | 1060 | 1150 | 1080 | 910 |
| Flow temp FT | °C | 1170 | 1130 | 1160 | 1090 | 1170 | 1120 | 990 |
| Fusibility characteristics of winter reed | | | | | | | | |
| Deformation temp DT | °C | 800 | 1040 | 1220 | - | 790 | - | 1050 |
| Shrinkage temp ST | °C | 1240 | - | - | - | 1040 | - | 1200 |
| Hemisphere temp HT | °C | 1290 | - | - | - | 1230 | - | 1270 |
| Flow temp FT | °C | didn't melt at 1330 °C | | | | 1270 | - | 1290 |

Based on our results common reed has proved to be suitable as a fuel in commonly used furnaces. Further tests will be needed to optimize fuel handling and combustion equipment in order to address the variable quality of the material. Large variety in reed biomass yield data (Ritterbusch, 2011), as well as differences in chemical composition and physical properties show that further studies about the productiveness and environment friendly utilization is needed (Barz et al., 2006). Also the behaviour of common reed in co-combustion with other biomass-based fuels needs further study.

Upgraded fuels from reed (solid, liquid and gaseous)

Different technologies for energy production are available, partly commercially and partly at the experimental stage. In the case of combustion plants and other consumers when biomass fuels are used far away from reed beds, the reed material has to be condensed or transformed in order to be able to transport the reed biomass with high energy density economically. Solid reed fuel can be produced by chopping the reed stalks into short lengths (5-10 cm), baling to round or square bales, pelletizing or briquetting followed by carbonization to char. As previously explained, for the production of solid reed fuels the winter harvested reed suits the most. The primary energy content of one 400 kg bale is about 1.5 MWh at the moisture content of 20%. Another option to increase the energy density of growing reed is to prepare liquid and gaseous biofuels, like biogas, biomethane, bioethanol, bio oils, etc. The summer harvested reed is more suitable for these purposes (bio oils can be made from the winter reed), although the summer mowing can damage the reed beds (rhizomes) and decelerate their growth.

Preparing reed pellets and briquettes

At the farm scale the device Agri 20 that produces pellets with the diameter of 8 mm and length varying from 8 to 40 mm (Figure 4.4, lower) can be used for pressing the reed pellets. For pressing briquettes, for instance, the machine RL-50BM of the Taiwan SK Machinery Co Ltd is available. The length of reed briquettes is about 80 mm and diameter 50 mm (Fig-

ure 4.4, upper). The recommended density for high quality pellets is a little more than $1\,100\text{ kg m}^{-3}$, which is the same as density for briquettes, but in the last case it can be achieved by addition peat or other suitable materials (Kronbergs et al., 2011). The volumetric density of pellets is $600\text{-}650\text{ kg m}^{-3}$.



Figure 4.4. Reed pellets (lower) and reed briquettes (upper) (Photo: Ülo Kask)

The reed pellets pressing device Agri 20 (Figure 4.5) is made in the Republic of South Africa. When using a mixture of two herbaceous biomass species where 80% is alfalfa (*Medicago sativa*) and 20% corn, the productivity of this press remains in the range of 150-200 kg/h of pellets. The initial reed material for pelletizing has to be dry (moisture 14-16%) and chopped into small pieces with the length of 2-3 mm.

After exiting the machine the reed briquettes expanded to some extent and cracked/crumbled. The hot biomass briquettes and pellets should be packed airtight as soon as possible before they cool down, so that they would not absorb humidity that would crumble the production. Pellets are extremely dense and can be produced with a low moisture content (below 10%) that allows them to be burned with very high combustion efficiency. The average calorific value of reed pellets and briquettes is over 16.5 MJ/kg (4.7 – 4.8 MWh/t). 2 tons of reed pellets is approximately equal to 1 000 litres heating oil.

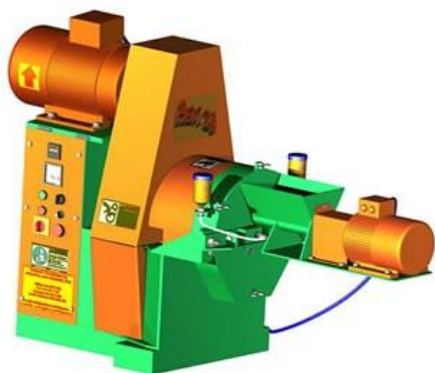

Figure 4.5. A press for pelletizing herbaceous biomass Agri 20

A simple drying technique requires 0.8 MWh of heat to dry a ton of pellets to the moisture content of 8-10% whereas the indirect techniques can significantly reduce the energy demand of drying process. Energy is saved by using a pre-dryer and condenser, which condenses the moist gases from the dryer directly. This drying process is more energy efficient, but requires higher investment costs.

Preparing biogas and bioethanol

Particularly, only few experimental results are available on using the reed for biogas and bioethanol production.

The experience of using the reed for biogas production is rather limited (Komulainen et al., 2008). The winter reed is too dry and therefore, only summer reed can be used for the production of biogas. The content of nutrients in winter reed is also lower compared to the summer reed that diminishes methane

digestion by the bacteria (Komulainen et al., 2008). The experimental study results at Tallinn University of Technology revealed that the biogas yield of summer reed is about 0.14-0.19 m³/kg (140-190 m³/t) and biogas calorific value is approximately 6 MWh/1000 m³ (Kask, unpublished). Another study from Finland (Jagadabhi et al., 2011) showed that two-stage anaerobic digestion could provide the methane yield of 0.26± 0.008 m³/kg for the fresh reed material that is comparable to the biogas yield of maize silage, which is about 0.20-0.23 m³/kg of fresh matter (Põllumajanduses..., 2005).

The excess sludge from the biogas production can be used as an organic fertilizer. Harvesting of natural reed in summertime can be problematic due to the possible negative environmental impacts, mainly damage to the rhizomes of reed, in a shallow water-body.

Lignocellulosic biomass (incl. reed) is an attractive alternative material for the bioethanol fuel production. Lignocellulose is the most abundant renewable resource on Earth, and constitutes a large component of the wastes originating from municipal, agricultural, forestry, industrial sources and landscape maintaining. The use of lignocellulosic materials would minimize the conflict between the land use for food and feed production and energy feedstock production. For instance, the reed in wetlands can be grown (or growing of itself) without any input of fertilizer, pesticides and energy.

Only few experimental results are available on the use of reed for the production of bioethanol. For example, some research groups from Portugal and Hungary have undertaken a collaborative effort aiming at developing a sustainable technology for the production of second generation bioethanol from non-food native reed in Hungary, as a feedstock. It was concluded that the conversion process to bioethanol per se does not present any major obstacles and the very high biomass yield of the reeds makes them candidates for the potential replacement of currently used crops for commercial bioethanol (Costa-Ferreira et al., 2011). Another study that aimed to investigate the glucose yield from biomass and their suitability for bioethanol production was carried out in Estonia. The experimental results showed that the glucose

yield of Common Reed collected in a lake was rather similar to silage and, for example, much higher than the yield of sunflower (Tutt & Olt, 2011) that gives an idea that reed can be used for bioethanol production.

Bioethanol, a colourless liquid, is an alcohol whose chemical formula is C_2H_5OH . Today bioethanol is mostly obtained by the fermentation of sugar beet, sugarcane, corn, barley, wheat, woody biomass or black liquor. The production involves generally large-scale facilities. For the future, lignocellulosic biomass is expected to be an important feedstock and its use would reduce competition for raw material between the food and energy industries. Since the characteristics of lignocellulosic biomass differ from those of other forms of biomass, the technologies for biofuels production have to be adapted for this use.

Depending on the feedstock considered, its availability for bioethanol production can vary considerably from season to season, and depending on geographic locations, could also pose difficulties in their supply. The changes of the prices of feedstock can highly affect the production cost of bioethanol. Because feedstock typically account for greater than one-third of the production costs, minimizing the bioethanol yield would be imperative (Soccol et al., 2011). However, like for anaerobic conversion, bioethanol production from herbaceous biomass is still not competitive if compared to other conversion processes. Each country must find the best and economical way to use their feedstock and residues in order to produce bioethanol. However, the use of each source of biomass represents a technological challenge. The use of fungi, reported by Sanchez (Soccol C. R., et al., 2011) in low-cost bioremediation projects might be attractive given their highly efficient lignocellulose hydrolysis enzyme machinery.

Transforming equipment from reed to energy (boilers, engines, CHP etc.), the types, suppliers and prices

The calculations based on 50,000 ha of naturally growing reed in Sweden with the average biomass production of 5 t/ha, give a theoretical energy value of roughly 1 TWh (Graneli, 1984) that is less than 1% of the total national energy consumption (about

360 TW). It is quite low compared to the total consumption of energy generated from biomass in Sweden that is 115 TWh

(<http://www.renewableenergyworld.com/rea/news/article/2010/06/biomass-generates-32-of-all-energy-in-sweden>).

A study carried out in Estonia showed that one ha of reed-bed could provide 23-27 MWh of primary energy, assuming that 6-7 tons per ha of winter reed yield is harvested and calorific value of reed at the moisture content of about 20 % is 3.9 MWh/t (Kask et al., 2007).

Different technologies for reed based energy production are available, partly commercially and partly at the experimental stage. Particularly, only few experimental results are available on using the reed for biogas and bioethanol production. The simplest use for winter reed is to make round or square bales and burn them in applicable furnaces or boilers (Figure 4.6). The primary energy content of one 400 kg bale is about 1.5 MWh at the moisture content of 20%. Burning of reed bales requires equipment that is suitable for the combustion of straw bales (straw packages) and other herbaceous fuels. The capacity of this equipment usually does not exceed 0.5-0.8 MW and the annual average efficiency is not higher than 70%. This equipment is usually relatively inexpensive.



Figure 4.6. Boiler for burning round and square grass and straw bales (Photo: Ü. Kask)

The bales of herbaceous biomass (packages) can also be used in larger boiler plants (in CHP plants) where they are transported into the furnace with the respec-

tive feeders. The reed bales burn out when moving downward along the grate or in the so-called cigar burner (Figure 4.7). With this technology there is no need for shredding the bales, as they go directly into the furnace. The capacity of this equipment reaches 4–6 MW. Another option includes preliminarily shredding of the bales and transport of crushed reed into the furnace either with a screw conveyor or by blowing in with the forced airflow. In the latter case either stoker boilers or fluidized bed boilers are used with the capacity that may reach tens of megawatts.

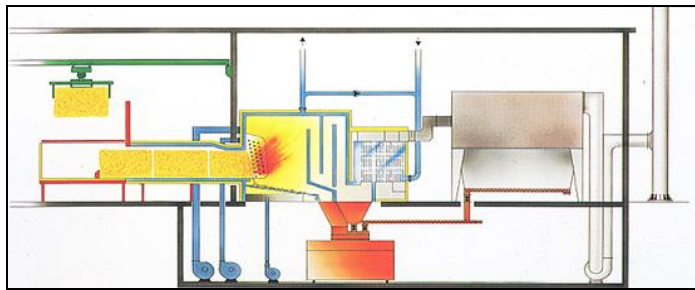

Figure 4.7. Vølund “cigar burner” technology for big bales.

The herbaceous biomass shred to a suitable size can be burned in the mix with fossil fuels or wood fuel and peat as well. The industrial use of reed for energy production started in Lihula Parish, Estonia in 2010 after reconstruction of an old boiler house (OÜ Lihula Soojus). The old oil-shale oil boiler was replaced by the Danstoker biomass boiler (1.8 MW) with the aim to use local meadow hay, straw and reed resources as well as wood residues (Figures 4.8 and 4.9). The annual energy production of the facility is 4.2 GWh and it uses about 1 000 tons of hay or reed plus 200 tons of wood chips annually. The new technology decreased both the CO₂ and SO₂ emissions by 98% compared to oil shale oil burning. The energy price for the consumers also decreased from 57.71 EUR/MWh to 54.96 EUR/MWh after it had been taken into operation in 2010-2011 (VAT is not included).



Figure 4.8. Hay (left) and reed (right) on a conveyer belt at Lihula Boiler House (Photo: Ü. Kask)



Figure 4.9. Danstoker biomass boiler at Lihula Boiler House (Photo: Ü. Kask)

One common low-cost solution when changing from heating oil to pellets in small boiler houses is retrofitting the old oil-fired furnace with a new burner designed for pellets. Several pellet burners convenient for substitution for oil burners are already available on the market. These are relatively simple but functional devices that in general give lower emissions than the best firewood boilers. Oil furnaces, however, are not designed for fuels that leave some amounts of bottom ash like wood pellets or in particular grass pellets. Therefore frequent emptying from ash is necessary to prevent the drop in efficiency or even hinder filling of the combustion chamber with ash. This can be taken care of with simple equipment with the intervals depending on the season and the type of used pellets. All types of pellet burners don't suit for the combustion of herbaceous biomass pellets (according to the tests in TUT DTE).

The advanced combustion systems for herbaceous biomass pellets contain an underfeed gasifier, ring nozzle burner (Figure 4.10), high-temperature bounce dome and turbulent burnout zone. Usually the capacity of this equipment remains in the range that can be used for heating a single family house (15–100 kW, Figure 4.11). The boilers in this range are an optimal solution for supplying heat to single-family houses, to larger buildings in residential and public sector (e.g. agricultural buildings, schools, commercial buildings, etc.) as well as smaller district heating networks. These types of boilers are characterized by flexible use of fuel and it is essential that different types of pellets can be used.



Figure 4.10. The ring nozzle burner (Photo: Ü. Kask)



Figure 4.11. KWB Multifire boiler, Austria (Photo: Ü. Kask)

Reed combustion tests

Laboratory tests in the TUT DTE

In the Boiler Laboratory of the Department of Thermal Engineering at Tallinn University of Technology combustion tests with the reed only and mix of reed and woodchips have been carried out since 2002. The pilot plant consists of a fuel hopper with mechanical blender from where the fuel is directed with auger feeders to the stoker burner, and boiler with the 250 kW nominal capacities (when the boiler is fired with woodchips).

The best for the pilot plant appeared to be manually crushed reed with the stem height of 4 – 7 cm. When using a blended fuel, it turned out that the higher the percentage of woodchips was in the mix, the more the auger feeder delivered fuel. The most optimal ratio of fuels and the corresponding capacity was obtained with the ratio where there were 5.5 mass units by weight of woodchips per one mass unit by weight of reed (1:5.5), or 1 m³ of reed was blended with 1 m³ woodchips. The moisture content of reed was 7 % and that of woodchips 50.5%. The boiler capacity up to 120 kW was reached. In Figure 4.12 we can see a rare ash cone left on the grate of stoker burner. At the same time the organic matter burns almost totally out (for ~98 %). When to burn reed only in the fuel wood and straw combustion boilers, problems may occur with ash disposal from the furnace due to its large volume and stable structure (Kask et al., 2007).



Figure 4.12. Reed ash residue after the combustion test (Photo: Ü. Kask)

Combustion of upgraded reed fuel

Some reed pellets combustion tests were made in the TUT TED laboratory with the boiler Pelle (the nominal capacity on light fuel oil is 30 kW). In the burner IWABO Fastighet 30 the auger feeder pushes fuel onto the grate. The ashes of burned fuel fall onto the bottom of the furnace over the front edge of burner under the pressure of fresh fuel pushed on the grate. Three hours after the ignition of reed pellets the burn-

ing process slowed down due to the burner clogging (the same had happened earlier when the combustion of straw pellets was tested). Evidently the reason for burner clogging was a non-collapsing ash cone of ~ 100 g. When touching the ash with the hand, you got the sensation similar to kneading mineral wool. The average heat input of the boiler during testing was 19.2 kW and useful heat output ~17 kW. During stable running of the boiler the mean flue gas temperature was 146.7 °C. The heating value of both reed pellets and briquettes at the moisture content of 8-9% was about 16.5 - 17 MJ/kg (energy content 4.6 – 4.7 MWh/t). The unburnt part of ash or loss from mechanically incomplete burning was 0.33% (Figure 4.14). In the core of ash heap sintering could be observed that could have been fostered by the reflector arch above the grate.

After changing the IWABO pellet burner to BioLine 25 (Figure 4.13) the average capacity 20 kW could be kept continuously.



Figure 4.13. Pellet burner BioLine 25 (Sweden) (Photo: Ü. Kask)



Figure 4.14. Combustion residues after test (Photo: Ü. Kask)

Conclusions drawn from the reed pellets combustion

The best way to burn the herbaceous biomass pellets would be in the stoker burner where the fuel is delivered to the circular burner head (so-called ring nozzle burner) (Figure 4.10) from below upward by an auger feeder. In this case the ash should fall homogeneously over the burner edge to the furnace. For burning herbaceous biomass the grate of pellet burner should be a travelling grate equipped with the mechanical ash handling system. All types of pellets can be burned in regular ovens when a special fire resistant steel basket with a lot of fine holes for air is installed in the furnace.

Reed briquettes combustion test

The reed briquettes were tested in regular ovens (combustion chamber without a grate). In one case the briquettes were placed on firewood billets and in the second case only reed briquettes were burned. The briquettes caught fire easily and burned with a vigorous flame. If the briquettes are piled in the fur-

nance, the upper layer burns well, but since the formed ashes do not crumble, but preserve the framework, they bury the lower briquettes (also billets when briquettes have been piled on them). Then the ash layer prevents access of air to the lower level of briquettes (billets) and does not allow them burning out properly. When the briquettes are spread relatively homogeneously on the furnace floor, they burn out better, but not completely. Thus the fuel pile has to be stirred from time to time anyway. Better results may be giving the combustion of reed briquettes in the oven with the grate.

As a conclusion we can state that it is rather inconvenient to burn reed briquettes in regular ovens (evidently in kitchen stoves too) since the fuel has to be stirred often and relatively high amount of ash is formed.

Pilot tests at Kuressaare Soojus Ltd

The first tests for the industrial combustion of reed were carried out in the Kalevi Boiler Plant of Kuressaare Soojus Ltd (Saaremaa, Estonia) in the beginning of August, 2003. The reed residues of roof building material were transported to the storage facilities of the boiler plant. The residues were pressed and packed with a straw packing machine in the fuel storage of boiler plant.

The first pilot tests were carried out in the Kalevi Boiler Plant of Kuressaare Soojus Ltd in the beginning of August, 2003. The reed residues of roof building material that were pressed and packed with a straw packing machine were transported to the storage facilities of the boiler plant where residues were blended with woodchips. Their tying cords were removed and a grab crane blended the reed with the mix of bark and sawdust. Then the mix was transported by a drag chain conveyor to the furnace. The length of reed remained in the range of 20–40 cm and its share in the burned fuel was about 7 % (by weight). The combustion caused no problems, only once too much reed occurred in the intermediate bin in front of the boiler that somewhat prevented fuel feeding to the furnace. The burned reed gave additionally 5.5–6 MWh of heat.

Two wood fuelled boilers have been installed in the Kalevi Boiler Plant (4 MW Saxlund and 6 MW

DKVR). The boilers are fed from common storage, but due to the technical solution of the fuel feeding system, reed cannot be used as an ingredient to wood fuel when both boilers are run simultaneously. The latter circumstances became evident at the follow-up tests in September. The problem was that the auger feeder that delivers fuel to the Saxlund boiler could not get enough fuel from the distributing bin located after drag chain conveyor.

The estimated length of reed should remain within 10 – 15 cm. The reed reserves in the Saare County are sufficient to supply fuel reed to the Kalevi Boiler Plant of Kuressaare Soojus Ltd in order to replace 10% of wood fuel with reed when a technically suitable and economically feasible logistic system for harvesting, shredding and burning reed will be found.

The results of combustion tests could say that reed has its segment as an auxiliary fuel in bio-energy plants where mainly wood fuels are used but not only, several grasses and peat are available too. The lack of entrepreneurs in the industry and proper harvesting machinery, and the fact that reed is a seasonal bio-fuel, are so far the obstacles to utilizing reed widely as a local bioenergy source. Using reed in small-scale energy plants and equipment is much more likely, particularly in the construction materials industry where waste reed could be converted into fuel energy.

The use of reed for combustion may be limited by transportation to longer distances where increasing of the density of the possible pelletizing material, baling or briquetting reed is required (Komulainen et al., 2008). Relatively high ash content also requires implementation of suitable technologies.

Life + “Green Pellets project on herbaceous bio-fuels” – Landry Jaglin (Green Pellets 2013)

In the frame of EU Life + project “Green pellets project on herbaceous biofuels” (France) some reed combustion tests were carried out. A multi-fuel boiler with the lower temperature firebox and moveable grate (grills) and with ceramic duct was used (Figure 4.15).

Conclusion on reed fuel tests

Reed composition can be highly variable, regular analyses are necessary to control the fuel composition. It is a dry product with a good calorific value. Reed could be used in industrial boilers; larger boilers could be fitted with smoke treatment systems. In small scale boilers reed mix with wood (with similar water content) can be used. It would be better to choose a multi-fuel boiler equipped with ceramic ducts. Regular boiler setting and maintenance are necessary.

Energy production from pellets requires improvement of the quality of feed system and homogeneity of wood/reed mixes, but increases logistics and energetic costs. In few years, benefits from energy production could offset the harvest costs. Energy production can be complementary to other benefits, but it is not the main target, which is natural area conservation.

Advantages of reed fuel: high calorific value, high ash melting point (little risk of clinker formation). Disadvantages: composition variability, bulkier fuel than wood chips, more irregular particle size, high ash, chlorine and sulphur levels.

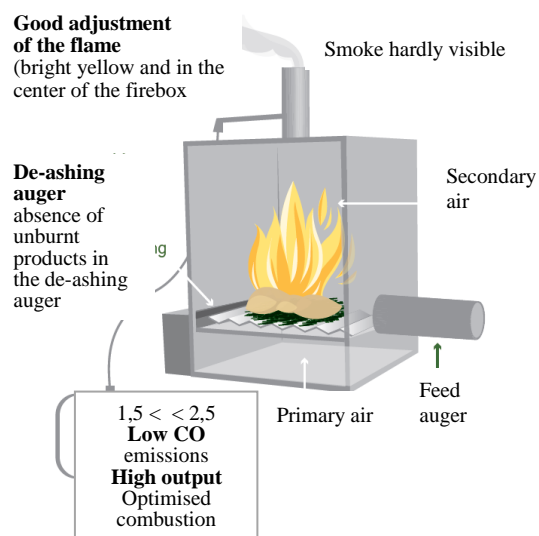

Figure 4.15. Layout of the test boiler

Acknowledgement

The authors thank Arvo Iital (Department of Environmental Engineering) and Siim Link (Department of Thermal Engineering), for their contributions to the preparation of this chapter.

References

Alakangas, E., 2000. Suomessa käytettävien poltoaineiden ominaisuuksia. VTT Tiedotteita 2045. Valtion Teknillinen Tutkimuskeskus, Espoo, 2000. 196 p.

Balevičiene, J., Balevičius, A., Stanevičius, V., Vaitkus, G., Gurova, E., 2007. Kuršiu mariu pakrantes augmenijos pjojimo, siekiant iš mariu pašalinti dalį biogeniniu medžiagu, galimybiu studija, Pagal sutartį su aplinkos apsaugos agentūra (In Lithuanian), 70 p.

Barz, M., Ahlhaus, M. and Wichtmann, W., 2006. Energetic Utilization of Common Reed for Combined Heat and Power Generation. In: Use of Bioenergy in the Baltic Sea Region. Conference Proceedings. 2nd International Baltic Bioenergy Conference 02. – 04. Nov. 2006, Stralsund, Germany, 168-175 pp.

Brix, H., 1999. The European research project on reed die-back and progression (Eureed). *Limnologica* 29, 5–10.

Brix, H., Sorrell, B.K. and Lorenzen, B., 2001. Are Phragmites-dominated wetlands a net source or net sink of greenhouse gases? *Aquatic Botany* 69, 313–324 pp.

Costa-Ferreira, M., Sousa J., M. and Lageiro, M., 2011. Bioethanol production using native reeds from Portugal and Hungary – a collaborative study.

Eesti riikliku keskkonnaseire allprogrammi “Eesti maastike kaugseire” 2009. aasta aruanne. Leping nr. 18-20/308. Tartu Observatoorium. Tartu-Tõravere 2009-2010, 29 p.

Fiala, K., 1976. Underground organs of *Phragmites communis*, their growth, biomass and net production, *Folia Geobot. Phytota*, 2, 225-259 pp.

- Graneli, W., 1984. Reed *Phragmites australis* (Cav.) Trin. ex Steudel as an Energy Source in Sweden. *Biomass* 4, 183-208 pp.
- Graneli, W., 1984. Reed *Phragmites australis* (Cav.) Trin. ex Steudel as an Energy Source in Sweden. *Biomass* 4, 183-208.
- Holmberg, R., 2009. Perspectives for R&D in Bioenergy in the Baltic States. Nordic Council of Ministers, 47 p.
- Huhta, A., 2007. To cut or not to cut? The relationship between Common Reed mowing and water quality. In: Read up on reed (Eds. Ikonen, I. and Hagelberg, E.), Southwest Finland Regional Environmental Centre, 2007, 30-37 pp.
- Iital, A., Klõga, M., Kask, Ü., Voronova, V., Cahill, B. 2012: Reed harvesting. Compendium. An Assessment of Innovative and Sustainable Uses of Baltic Marine Resources. Maritime Institute in Gdansk, 2012. 103-123 pp.
- Jagadabhi, P. S., Kaparaju, P., Rintala, J., 2011. Two-stage anaerobic digestion of tomato, cucumber, common reed and grass silage in leach-bed reactors and upflow anaerobic sludge blanket reactors. *Biore-source Technology* 102, 4726–4733.
- Kask, Ü., Kask, L., 2013. Pilliroog ja selle kasutus. *Eesti Loodus* 2/2013, Tallinn, 28-51 pp.
- Kask, Ü., Kask, L., Link, S., 2013. Essential properties of reed and their influence on combustion equipment. Given to Peat and Mires. Not published since.
- Kask, Ü., Kask, L., Paist, A., 2007. Reed as Energy Resource in Estonia. In: Read up on reed (Eds. Ikonen, I. and Hagelberg, E.), Southwest Finland Regional Environmental Centre, 2007, 102-114 pp.
- Komulainen, M., Simi, P., Hagelberg, E., Ikonen, I. and Lyytinen, S., 2008. Reed energy – Possibilities of using the Common Reed for energy generation in Southern Finland. Reports from Turku University of Applied Sciences 67, 78 p.
- Kronbergs, E., Kaķītis, A., Nulle, I., Šmits, M., Kronbergs, A., Repša, E., Širaks, E., Ancāns, D., 2011. Common reed biomass opportunities for production of biofuel pellets and briquettes, 21 p.
- Kütuse- ja energiamajanduse riiklik pikaajaline arengukava aastani 2015 (visiooniga 2030), 2002. Tellimustöö aruanne. TTÜ elektroenergeetika ja soojustehnika instituut. Tallinn, 2002. 104 p.
- McKendry, P., 2002. Energy production from biomass (part 1): overview of biomass. *Biore-source Technology* 83, 37–46 pp.
- Meyerson, L.A., Saltonstall, K. and Chambers, R.M., 2009. *Phragmites australis* in eastern North America: a historical and ecological perspective. In: Silliman, B. R., Grosholz, E. Bertness, M. D. Salt marshes under global Siege. Univ. of Cal. Press, 57-82.
- Paist, A.; Kask, Ü.; Kask, L., 2007. Composition of reed mineral matter and its behavior at combustion. 15th European Biomass Conference & Exhibition: From Research to Market Development: Proceedings of International Conference held in Berlin, Germany 7-11 May 2007. Berlin: ETA-Renewable Energies, 1666 – 1669 pp.
- Põllumajanduses kasutatavate biogaasiseadmete gaasitootlus, 2005. Translated from: Mecklenburger Biogas Gesellschaft mbH, 21 p.
- Räikkönen, N., 2007. Reed is not uniform. Classification of reed beds and reed biomass and quality mapping. Case study in Turku and Salo, Southwest Finland. In: Read up on reed (Eds. Ikonen, I. and Hagelberg, E.), Southwest Finland Regional Environmental Centre, 2007, 17-22 pp.
- Ritterbusch, D., 2011. Nutzung von Rohr/Schilf - ein umweltverträgliches Entwicklungspotenzial für die Fischerei? Schriften des Instituts für Binnenfischerei e.V. Potsdam-Sacrow, Bd. 30. Hrsg. Institut für Binnenfischerei e.V. Potsdam-Sacrow, 79 p.

Rodewald - Rodescu, L., 1974. Das Schilfrohr *Phragmites communis* Trinius. Die Binnengewässer 27.1-302. Schweizerbartsche Verlagsbuchhandlung (Nägele u. Obermiller), Stuttgart.

Roosaluste, E., 2007. The Reed itself-*Phragmites australis* (Cav.) Trin. Ex Steud.: taxonomy, morphology, biology, ecology, problems. In: Read up on reed (Eds. Ikonen, I. and Hagelberg, E.), Southwest Finland Regional Environmental Centre, 2007, 8-10 pp.

Roostike strateegia Väinamere piirkonnas 2008-2018, 2008. Tallinna Tehnikaülikool, Riiklik Looduskaitsekeskus, Tartu Ülikool, TTÜ Kirjastus, 55 p.

Soccol, C. R., Farcao, V., Vandenberghe, L., Thomaz-Soccol, V., Woiciechowski, A., Pandey, A., 2011. Lignocellulosic Bioethanol: Current status and future perspective. In *Biofuels* (Eds. Pandey, A., Larroche, Chr., Ricke, S. C., Dussap, C-G., Gnanasounou, E.), Academic Press of Elsevier, 2011, 101-122 pp.

Soetaert, K., Hoffmann, M., Meire, P., Starink, M., van Oevelen, D., van Regenmortel, S. and Cox, T., 2004. Modeling growth and carbon allocation in two reed beds (*Phragmites australis*) in the Scheldt: *Aquat. Bot.*, Vol. 79, 211-234 pp.

Timmermann, T., 2003. Nutzungsmöglichkeiten der Röhrichte und Riede nährstoffreicher Moore Mecklenburg-Vorpommerns, Greifswalder Geographische Arbeiten 31, 31 - 42.

Tutt, M. and Olt, J., 2011. Suitability of various plant species for bioethanol production. *Agronomy Research Biosystem Engineering Special Issue 1*, 261-267 pp.

Van der Putten, W.H., 1997. Die-back of *Phragmites australis* in European wetlands: an overview of the European Research Programme on Reed die-back and progression (1993–1994). *Aquat. Bot.* 59, 263–275 pp.

Vares, V., Kask, Ü., Muiste, P., Pihu, T., Soosaar, S., 2005. *Biokütuse kasutaja käsiraamat*. Tallinna Tehnikaülikool, Tallinn 2005. 172 p.

Wichmann S. and Wichtmann W., 2009. *Energiebiomasse aus Niedermooren (ENIM)*. 190 p.

Green Pellets

http://www.aile.asso.fr/?page_id=1491&lang=en

Photo on previous page by Ü.Kask

5. Reed Supply Chains, Mowing Equipment and Technologies, Logistics, Environmental Impact from Reed Supply Chain, Supply Risks

Ülo Kask, Livia Kask, TUT

Reed growing in open water (sea, lakes) could be cut more economically in winter when ice or frozen ground allows access for heavy machinery. Also on coastal meadows with soft soils, harvesting is possible only when the surface is frozen. Another important aspect of winter reed harvesting is that its moisture content is suitable for use in roofing material and energy transformation (incl. solid biofuels, but excl. biogas).

Reed supply chain

The first link of the reed supply chain is harvesting, which consists of activities like mowing, chopping (crushing), baling and transportation of primarily processed reed to storage or interim storage. If reed is harvested as construction material after mowing bundling is needed. Generally reaper (for instance Seiga) makes it. The mowing machine (reaper) could just chop the reed or bale it, depending on what additional equipment (accessories) is available.

The next link of the chain is transport. The first stage of transport is completed in the interim storage next to the site where reed has been mown or in the main storage. It can be considered as a phase of harvesting too. The pre-treated reeds are transported to the building site (for instance to the building with a thatched roof) or processing plants (biogas station or reed insulation mats manufacturing company). Reed can also be transported to the processing factory for export to foreign countries.

The third link is processing. Processing or treatment may involve several steps, depending on where the reed is used. If reed is used for roofing, the bundles made by machine must be cleaned from low quality and inappropriate stalks and only then they correspond to special roof-mounted bundles (sheaves, 2.5-3.5 kg). For long-distance transportation so-called transport big bales are prepared from small

bundles (25-50 bundles in one bale). As reed for energy transforming purposes is used several steps of processing may be applied. Before anaerobic treatment in biogas station the reeds should be ensiled.

If the reed is collected in the winter and large round or square bales are made, they can be burned without modification in the boiler or must be chopped before transmitting to the furnace; it all depends on combustion devices. Pelletizing and briquetting would need additional drying, grinding and only then pressing, cooling and packing of reed.

Last link in the reed supply chain is delivering the end products to the consumers. The end products are considered to be energy (heat, electricity), fuels (round bales, pellets, biogas, bio-methane, bio-ethanol etc.), construction materials (insulation mats, bundles etc.), fertilizers (compost, mulch, digesting residue etc.) and other options (reed flute, reed pen, art objects etc.).

Harvesting time and conditions (Komulainen et al., Reed Energy)

The common reed can be harvested for energy use both in winter and in summer, for construction material only winter harvested reed is qualified. Reed harvesting takes place in the water bodies with soft, often muddy bottoms. The rhizome system of reed is also rather vulnerable to direct damages. Therefore, national regulations can restrict harvesting during spring and summer. National regulations can also establish the contact pressure per unit area (specific pressure on ground) of harvesters and transport vehicles that, for example, should not exceed 100 g/m² in Germany (<http://www.hiss-reet.com>). The dry reed harvested in winter and early spring is used for burning, and the summer harvested green mass could be used for biogas or bio-ethanol production. The harvesting time should be tailored according to the

weather conditions, quality properties of the material and other values as well as utilisation interests regarding the reed beds.

When the reed is used for combustion in boilers, an important factor is the moisture content of reed mass. The relative moisture is the lowest in winter to spring time, March – April (see Chapter 4). Even then the harvesting should be done at midday when the morning moisture has evaporated. Also rain does not necessarily hinder harvesting, since even after a longer

period of rain the standing reed dries up to its pre-rain moisture levels in few days.

The ice in the reed bed areas is generally weaker than in the open water areas, since the reed beds and the “reed peat” (layer of old reed stalks) formed by the old reed matter generate heat during natural anaerobic digestion process (Figure 5.1). It can be assumed that if the reed could be gathered by yearly harvest, the decomposing matter would decrease and ice would thicken, so it could also carry better the harvesting machines.



Figure 5.1. Water on the weak ice at Turbuneeme, Estonia, February 2007 (Photo: Ü. Kask)

The green reed mass for biogas production is harvested in late summer (second half of July and August) after the most sensitive phases of the nesting of reed bed bird species. Harvesting done in early summer may stop the growth and damage the

rhizomes. The choice of cutting height is instrumental: cutting the reed under the water level makes the growth stop, whereas harvesting by cutting above the water level and especially in late summer does not jeopardize the growth of the reed in summers to come. The summer reed mass harvested for biogas

production also decreases the nutrient load to the water systems, since late summer harvesting, before the nutrients are transferred to the rootstock to ensure the growth in the next season, is the most efficient

way of removing nutrients from the water systems. In conclusions on harvesting time and its impacts are given in Table 5.1.

Table 5.1. Seasonality aspects in planning reed harvesting and use

| Use | Suitable season for harvesting | Advantages and impacts |
|--------------------------------------|--------------------------------|---|
| Thatching | Winter | Moisture content is lower. Less damage to the rhizomes and other biota, especially if harvested on ice. |
| Combustion | Winter | Moisture content is lower. Low quality reed as well as panicles (blossoms) can be used. Primary energy content of winter harvested reed is higher compared to summer harvested reed. Less damages to the rhizomes and other biota especially if harvested on ice. |
| Production of biogas and bio-ethanol | Summer, early autumn | Green biomass is needed for anaerobic digestion. Low quality reed as well as leaves and panicles can be used. Harvesting in summertime is problematic due to environmental impacts (e.g. bird nesting period, other biota, damage to rhizomes). |
| Harvesting for nutrient removal | Early summer | Nutrient content of reed is at its maximum. Harvesting is problematic due to environmental impacts (e.g. bird nesting period, other biota, damage to rhizomes). |

Harvesting equipment and machinery (Komulainen et al., Reed Energy)

The reed grows in very different places ranging from the water areas to the dryer coastal areas. The different habitats and harvesting times (summer/winter) presuppose difference in harvesting equipment. In the choice of equipment, the defining factors are the technical requirements for harvesting and overall cost-effectiveness. The cost-effectiveness depends on, e.g., harvesting and transport costs as well as quantity of human work and harvesting losses. Some tests with reed canary grass have given the harvesting loss of 20-30 percent for the field chopper – the round baler combination.

The varying water level sets limits to winter harvesting, since it hinders the formation of dense

ice. Also snow piling up on the growths slows down the formation of the ice layer bearing the weight of the harvesting machinery and makes the harvesting more difficult also otherwise, and decreases the amount of the harvestable reed mass.

An essential technical factor in harvesting the reed is the weight of the machine and specific pressure on ground and ice induced by the working machine. The machinery on wheels is the most cost-effective considering the transportation between the work sites, although even the chain track structure decreases the surface pressure. Also extra wide tyres for tractors or machinery with tracks decrease the surface pressure. In winter, it is possible to harvest the reed with the existing farming machinery.

Different technologies for harvesting reed are widely in use and commercially available. Selection of technologies depends on the aim of reed-cutting and further use of reed. Selection between the machinery is partly dependent on environmental conditions also, i.e., whether it is salty or fresh water, with a muddy or hard bottom, whether the cutting will take place on ice or in the water, etc.



Figure 5.3. Small engine-driven BCS mower (left), mower with a wide header (right)



Figure 5.2. Hand-held cutter (sickle or scythe)

Quite simple technologies can be used when aiming just to clearance and maintenance of coastal areas and control of reed plants. Reed can be mowed by using simple equipment, e.g., hand-held cutter bar mowers (Figure 5.2) as well as light hand-operated engine-driven mowers (Figure 5.3), or reed cutters, which are mounted on small boats (Figure 5.4), or amphibian mowers (Figure 5.5). Hand cutting can be varied to suit the conditions and it can reach the small areas where machines cannot operate, but it cannot reach the speed of mechanical mowing: for hand cutting one man can cut about 1/5 hectare per day, while specially designed harvesters with a tractor are able to harvest 4 hectares a day. Selection between the technologies depends on the location (e.g. dry land or water), and the area treated. Raking machines are used to collect and transport away the reed biomass and remove that way stored nutrients and prevent nutrient re-release from decaying plants. In winter mowing can be done with a disc mower and harvesting with a self-loading wagon or a baler. Baling can be done using a round baler, square baler or hard baler. The most cost-effective alternative would be a large square baling machine (Figure 5.6).



Figure 5.4. Reed mower mounted on a small boat Doroklippenpen Hymo (<http://doroteamekaniska.se/hymo2.html>)



Figure 5.5. Floating mower Truxor Doroklippen ESM 2100 (<http://doroteamekaniska.se/2esm2100.html>)

but at the moment the price of the square baler is still high, and ice cannot bear the weight of the machine, 7-9 tons. The more commonly used round baler is more economical while the machine is lighter (Figure 5.7). The chopper commonly used in a square baler produces 5-10 centimetres long chopped stalks, which is pressed and tied with a cord. The hard baler that has been used the longest produces smaller bales

(20 kg) which raise the transportation costs, but instead the machine itself is light. The harvested reed can be transported to the shore with a self-loading wagon machine for further processing. On a good day the Seiga BCS cuts about 6 000 bundles a day, but requires a crew of 3-5 people (Figure 5.8). The normal work yield per day is ca. 4 000 bundles. The Seiga produces bundles that, if required for thatching, are superfluous when reed is meant to be used like biofuel. A bundle of medium length and diameter weighs 3.2-3.6 kg when dry and contains about 2 000 reeds. Even though the machine operates blamelessly, an even greater volume would be needed to harvest reed for bio energy raw material, and from the point of view of bio energy, the bundling is not economically efficient.



Figure 5.6. Large round baler 605 Super M Balers (http://www2.vermeer.com/vermeer/LA/en/N/equipment/balers/605_super_m)

Also available is a Polish caterpillar band machine especially designed for cutting reeds, based on a German light tractor and Italian BCS mower. The cutting capacity is ca 1 000 bundles per hour, depending on the reed bed, and the machine requires a crew of 2-3 persons. The equipment weighs 2 500 kg and can easily be transported on a chassis or pallet. The reed harvester still requires development to be applicable precisely for bioenergy harvesting. For instance, the BCS cutter should be replaced with a chopping blade and its walls built higher.



Figure 5.7. Large square baler Claas (upper) (<http://classified.fwi.co.uk/browse/grassland-equipment/balers/big-square-balers>)



Figure 5.8. Reed cutter Seiga BCS (Photo: Ü. Kask)

A machine, which so far is untested in Finland is the Wetland Harvester developed by the British Loglogic (Figure 5.9). It has been developed for harvesting especially in areas that require low pressure on ground from the equipment. After mowing the reed mass is directed into a chopper making chaff of 1-4 cm. The chaff is blown into a container of 6-8 cubic metres at the back of the machine. The manufacturers' suggested hour capacity for the ready chaff is 10 tons, which equals the harvest of ca 2 hectares. The problem is the high price of the machine.



Figure 5.9. The Loglogic Softrak harvesting machine (Photo: Ü. Kask)

A specific reed thresher has also been developed in Finland for harvesting of common reed. The upper part of thresher is such that reed can be harvested, baled and transported to the intermediate storage close to the shore using just one machine. The built-up reed thresher usually consists of the cutting table of an ordinary farm thresher, a bull chain conveyor, round baler and hind wagon with which the bales are transported to the shore. The equipment is promising in its operational principle, but has proven not to work very well in reed harvesting since it is too heavy.

The common reed, which will grow to the heights of even 3-4 metres, may require for its cutting gear something quite different from the equipment used in hay harvesting. The possible models for the equipment could be the same which are used for corn and *Miscanthus sinensis* harvesting.

Summer time harvesting of reed from water areas is quite a different problem since it takes place in water that can be as deep as 2 metres. The harvesting machine should both float and preferably also be run on land. It would also be a benefit if the transfer trips could be done without expensive arrangements and special transport. One of the options for summer harvesting is a floating tractor (Figure 5.10). The tractor floats on big tyres and pontoons and can be used for instance for the water systems conservation work. In principle, the floating tractor could be fitted with

cutting equipment, and the cut material could be guided to a floating trailer. The floating tractor could be used in winter reed harvesting just as an ordinary tractor.



Figure 5.10. Specially equipped Valtra C150 with a trailer in tow can mow reed in the lake (<http://www.valtra.com/news/405.asp>)

Others are for instance the Truxor (see Figure 5.5), a caterpillar band based mower built on pontoons, which can mow reed from the 1.5 meters water depth all the way to the shore. Amphibians can have certain advantages compared to heavy tractors, because they exert minimum ground pressure, thus avoiding ground damaging. Therefore harvesters, like the commonly used SEIGA, often use low ground pressure balloon tires to minimize impact on the bottom and rhizomes if harvested in water.

Industrial production of reed as a construction material or biofuel requires more sophisticated technologies that include tractors, cutters and platform to collect and transport reed. Some harvesters can chop the reed into chips, which can be pressed into pellets by special mobile machinery in mowing area (Figure 5.11). In conclusion some working parameters of mowing and baling machines are given in Table 5.2.

Table 5.2. Mean working parameters of mowers and balers (Santi, 2007)

| Machine | Working width (m) | Working speed (km/h) | Working capacity (ha/h) | Mean power demand (kW) | Mean energy required (kWh/ha) |
|--------------------------|-------------------|----------------------|-------------------------|------------------------|-------------------------------|
| Single blade bar mower | 1.3-2.6 | 5-7 | 0.6-1.3 | 2-7 | 4-11 |
| Double blade bar mower | 1.3-2.6 | 6-10 | 0.8-1.8 | 3-8 | 4-10 |
| Self-propelled bar mower | 1.3-2.6 | 4-5 | 0.5-0.9 | 6-9 | 12-18 |
| Disc mower | 1.5-2.5 | 12-15 | 1.1-2.2 | 6-15 | 5-13 |
| Small plunger type baler | 1.6-1.9 | 5-6 | 0.8-1.2 | 25-40 | 30-50 |
| Round baler | 1.6-2.0 | 5-7 | 1.0-1.5 | 40-50 | 40-50 |
| Giant baler | 2.0 | 5-7 | 1.2-2.0 | 40-60 | 35-50 |



Figure 5.11. Mobile straw pellet mill ZLSP200B, 300 kg/h

(http://agic.en.alibaba.com/product/526267059-213551517/ZLSP200_300kg_Straw_Pellet_Mill.html)

Transport and storage

An economical transport distance for straw-like bio-fuels is dependent on the quality of the material. For instance, economical transport distance for reed canary grass is at maximum 90-120 km depending on the quality of the material: in bulk unit transport the distance is shorter than in bale transport (Flyktman and Paappanen, 2005). In bulk harvesting, the chopped material can easily be mixed with peat or

chips (Figure 5.12) at the incineration plants, but the low energy density increases the transport costs. In order to increase density, reed should be baled or transformed into an even denser form, such as briquettes or pellets. Also the volume weight of bulk chopped reed can be increased with various pressing devices. The density of a round or square reed bale is approximately 140–170 kg/m³ (cf. bulk chaff min 30

kg/m³ up to 60 kg/m³) and thus its economical transport distance is longer (Komulainen et al., 2008).



Figure 5.12. Wood chips and reed mixture (20% reed by volume) (Photo: Ü. Kask)

It is difficult to load a round bale so that the flat surface is facing down and later flip it back up on edge, so transporting many round bales a long distance is a challenge: flat-bed transport is difficult since the bales could roll off the truck bed when going around curves and uphill. To prevent this, the flat-bed trailer is equipped with rounded guard-rails at either end, which prevent bales from rolling either forward or backward. Another solution for this is a saddle wagon, which has closely-spaced rounded saddles or support posts for round bales to sit in. The tall sides of each saddle, or the bale settling down in between posts, prevent the bales from rolling around while on the wagon. Square bales are safer and occupy less volume in the transport phase than cylindrical ones. It means that if a long haulage is required between the field and the site of transformation (e.g. more than 10 km), square bales have to be chosen to decrease transportation costs (Santi, 2007).

In the logistics chain of using the common reed for energy generation it is important to note the storage of the reed material also (Figure 5.13).

Even here the form of the material (chopped reed / bale / pellet) is decisive: the storage of the chopped reed presupposes large storage facilities and is also



Figure 5.13. Storing of large square bales in Lihula (Estonia) boiler house storage (Photo: Ü. Kask)

uneconomical (need of large storage facilities/ energy content). The chopped reed bulk equalling 1 MWh of energy requires averagely 4.2 m³ of storage, while as a hard bale it requires 1.5 m³ only. In Estonia the storage of reed, which is collected for building use or manufacturing insulation mats mainly takes place in old collective farm buildings. Once it is dry the reed stays intact for years, but the storage room must have good ventilation (Komulainen et al., 2008).

In the harvesting experiments in Estonia and Finland, reed was baled into large round and square bales as well as small square bales (~20 kg), and these bales were burned in combustion tests in boiler houses. At the Paimio district heating plant the fuel is stored outdoors, but in the Orissaare (Saare County) boiler plant indoors and burned mixed with wood chips or milled peat. Moisture in the fuel does play significant role if the relative moisture content of wood chips is between 40-50%. When a flue gas scrubber is used, the evaporated moisture in flue gases is converted into water during the condensing process and the released heat can be supplied to the district heating network.

Taking into consideration the average cost of reed mowing, baling to large bales and transportation, and the net calorific value of reed as received (3.97 MWh/t), the optimal transportation distance of compressed reed as energy fuel is from 25 up to 50 km radius of the neighbourhood of boiler plants or combined heat and power station. In this case it is the average price of biofuel, which would ensure the competitiveness of wood-based fuels (wood chips etc.). (Aavik, 2010)

The transport cost of bulk material is nearly 80 EUR/ton when the distance is 50 km and nearly 170 EUR/ton if 150 km (Puolakanaho, 2007). The transport costs of reed bales are somewhere in between. Therefore, both the transport as well as storage costs can be remarkably reduced with the compaction of reed by baling, briquetting and/or pelletizing. The baling cost can form nearly half of the overall harvesting costs that are up to 110 EUR/ha depending on the method (Komulainen et al., 2008).

Environmental impact of reed supply chain, Supply risks

Environmental impact in relation to the use of reed is negligible. The risks can mostly be characterised as violation of environmental rules for harvesting reed in reed beds. The list of possible damages includes:

- Water protection to remove excess nutrients from coastal waters by removing the reed. The impact is usually rather local and feasible mostly in areas where the use of reed and curative mud or other uses of coastal areas can contradict to each other. Bottom of the water body and sediments can also be damaged when using inappropriate technique or when harvesting in summer or autumn;
- Maintenance of biodiversity by providing suitable habitats for a number of animal species, especially for bird nesting and fish;
- Aesthetic and cultural values when maintaining the historical landscapes. Common reed as a traditional construction material and essential part of the coastal landscapes in many areas can lose its historical and aesthetical value due to intensive uses.

Especially a summer or an early autumn harvest could give rise to different problems with regard of the sustainable use of the reed resource (Granéli, 1984):

- The rhizomes can be destroyed by the harvester that decreases reproduction of the resource; Summer cutting could significantly decrease the growth and the aboveground biomass in the following year (Weisner and Granéli, 1989; Asaeda et al., 2006) and cutting below the water surface

could substantially inhibit the re-growth of shoots (Weisner and Granéli, 1989);

- Recharging of the rhizomes with nutrients is diminished through removal of the aboveground biomass that could decrease the next year's biomass;
- The summer harvested material requires energy-consuming drying, unless the material is used for biogas production;
- Serious disturbance on the environment, such as bird breeding areas.

Winter harvesting has several advantages compared to the summer or autumn harvesting (Graneli, 1984):

- No serious environmental disturbance occurs.
- Destruction of rhizomes can be prevented if harvesting is done from ice or on frozen soil.
- The culms do not need drying before being used as fuel or construction material.

Thus winter cutting has no or little effect on subsequent shoot production or biomass and better spring light conditions could even provide better conditions for reed growth (Granéli, 1990) and diminishes harmful effects of parasites on reed growth (van der Toorn and Mook, 1982; Kovács et al., 1989). According to Ostendorp (1991, and 1999] winter harvesting makes reed more dense but thin.

Winter harvesting has also some drawbacks (Graneli, 1984):

- Only about 50% of the yearly above-ground biomass can be utilized (as it used for thatching);
- Only small amounts of nutrients are removed from the system as most of the nutrients are recycled to the rhizomes.

Impact of harvesting of reed biomass in wetland environment is not well studied and assessment of economic feasibility of reed removal does not usually involve additional environmental services if combined with habitat management and nutrient removal. The reed as a natural resource (e.g. reed as a roofing material and biofuel for energy production, the value of reed for treatment of sewage waters) can easily be valued by using monetary units. At the same time it

is difficult to value the positive environmental impact of reed and reed beds. Sustainable use of reed resources requires consideration of all possible uses and treatment methods of reed and reed beds as well as willingness of the society to pay for maintenance of reed bed areas.

Reed is a CO₂ neutral fuel, which means possible savings for those power plants that are impacted by the emission trade. It is estimated that one hectare of reed bed equals to about 2 000 litres of light oil. When using the reed harvest from one hectare for energy production, about 6 tons of CO₂ emissions can be eliminated (Komulainen et al., 2008). Reed beds as well as other wetlands could emit considerable amounts of methane to the atmosphere. This greenhouse gas is produced in muddy conditions described by oxygen deficiency. Frequent harvesting and use of reed could reduce methane volatilization due to decreased sedimentation of organic matter (shoots and leaves) to the bottom of the sea.

If carefully managed, reed harvesting has the potential to further contribute to some of these ecosystem services through an increase in the capacity of the reed bed to remove nutrients, through resource efficient and renewable construction materials and through the production of bioenergy from harvested biomass. For sustainable approach it is, however, necessary to maintain a balance between the natural ecosystem services reed beds provide and developing the potential of reed beds to contribute further to ecosystem services.

The environmental priorities that are impacted by harvesting reed are water transparency, eutrophication, biogeochemical cycles, food web dynamics, biodiversity, benthic and bird habitats, fisheries, coastal morphology, scenery and climate protection.

Reed bed areas can favour nature tourism in a region knowing that reed beds provide favourable conditions for bird nesting and bird watching as well as a good fishing ground for fishermen. These environmental services are difficult to estimate and express by using monetary units.

Social and economic risks of fuel reed harvesting

The annually varying of weather conditions sets limits to harvesting. The breaking ice can destroy and hard winds flatten the reed beds (Figure 5.14). The success of winter harvesting is essentially tied to the snow situation and thickness of ice on the water. If freezing takes place in autumn when the water level is high and the levels drop after that, thin ice clinging to the reed stalks becomes an insulation layer which slows down freezing. In this case also air pockets between the layers of ice can break under the weight of harvesting machinery (Figure 5.16). From then on there is snowfall on the ice coating (Figure 5.17), the formation of the bearing ice is weakened. During some years poor ice conditions can prevent almost all the winter harvest of reed. In the worst case not even 10% of prior yield (Figure 5.15) can be harvested (Kask et al., 2007). Winter harvest would be smaller than summer one by 20-25%, because of leaf shedding and damage due to snow. In the future the climate warming can make winter harvesting, which is done on the ice much harder, complicated as the ice winter gets shorter and the ice thinner.



Figure 5.14. Ice damages in reed beds, at Toolse, Estonia, February 2007 (Photo: Ü. Kask)

Further rise in the price of machinery, equipment, motor fuel and labour power has also impact on the potential price of fuel reed. The producers of reed for

thatched roofs and building materials may become competitors to the reed suppliers who harvest fuel for local boiler houses if the demand for these products increases. The insulated reed panels are in demand



Figure 5.15. By visual estimation 80% of reeds are damaged at Sutu Bay, Estonia, April 2007 (Photo: Ü. Kask)

among the eco-friendly builders already today. Shredding or packing of the residues of roof reed sheaves to suit the boilers is a labour consuming and costly activity.



Figure 5.16. Multiple layers of ice in reed bed at Turbuneeme, Estonia, February 2007 (Photo: Ü. Kask)



Figure 5.17. High snowdrifts in the reeds in Loode tammik, Estonia, February 2007 (Photo: Ü. Kask)

The competitors to the reed supply as a raw material to district heating boiler plants may also be the reed pellets and briquettes producers. The demand and price of reed pellets are constantly increasing due to the price rise of liquid fuels. The market of both wood-based and herbaceous biomass pellets (briquettes) in Europe is far from being satisfied and a prosperous European consumer can pay higher price than an Estonian customer evidently for several more years.

Constant outflow of high-quality labour power from Estonia may give a serious impact on the rural regions - no workers willing to work left. This is why more effort and money must be spent on the labour power recruitment or higher price paid for the reed as a raw material. So-called “pinching” of raw material from reed producers would raise the price of reed as a fuel to an unacceptable level for the heat producer. The risk factor of malicious destruction of reed beds by putting them into fire cannot also be excluded (e.g., some years ago at Rocca-al Mare, Tallinn and Pärnu).

References

- Aavik, T., 2010. The technical, economical and environmental issues of the utilization of reed for energetic purpose. Master thesis, TUT 2010. 68 pp.
- Asaeda, T., Manatunge, J., Fujina, T. and Sovira, D., 2003. Effects of salinity and cutting on the development of *Phragmites australis*. *Wetl. Ecol. Management* 11, 127-140.
- Flyktman, M. ja Paappanen, T. 2005. Ruokohelven käyttökapasiteettiselvitys. Tutkimusselostus VTT
- Graneli, W., 1984. Reed *Phragmites australis* (Cav.) Trin. ex Steudel as an Energy Source in Sweden. *Biomass* 4, 183-208.
- Graneli, W., 1990. Standing crop and mineral content of reed, *Phragmites australis* (Cav.) Trin. ex Steudel, in Sweden – Management of reed stands to maximize harvestable biomass. *Folia Geobot. Phytotaxon.*, 25, 291–302.
- Iital, A., Klõga, M., Kask, Ü., Voronova, V., Cahill, B. 2012: Reed harvesting. Compendium. An Assessment of Innovative and Sustainable Uses of Baltic Marine Resources. Maritime Institute in Gdansk, 2012. 103-123 pp.
- Kask, Ü., Kask, L., Paist, A., 2007. Reed as Energy Resource in Estonia. Read up on reed, Ikonen, I., Hagelberg, E. Southwest Finland Regional Environmental Centre, 2007, 102-114 pp.
- Komulainen, M., Simi, P., Hagelberg, E., Ikonen, I. and Lyytinen, S., 2008. Reed energy – Possibilities of using the Common Reed for energy generation in Southern Finland. Reports from TUAS, 67, 78 p.
- Kovács, M., Turcsányi, G., Tuba, Z., Wolcsánszky, E. S., Vásárhelyi, T., Dely-Draskovits, Á., Tóth, S., Koltay, A., Kaszab, L., Szöke, P. and Jankó, B., 1989. The decay of reed in Hungarian lakes. *Symp. Biol. Hung.*, 38, 461–471.
- Ostendorp, W., 1991. Damage by episodic flooding to *Phragmites* reeds in a prealpine lake: proposal of a model. *Oecologia*, 86, 119–124.
- Ostendorp, W., 1999. Management impacts on stand structure of lakeshore *Phragmites* reeds. *Int. Rev. Hydrobiol.*, 84, 33–47.
- Puolakanaho, K., 2007. Logistics and activity-based costing of common reed’s automotive transportation. Turku UAS (in Finnish), 59 pp.
- Santi, S., 2007. Harvesting technologies and value-adding to bio-fuels of herbaceous biomasses. Master thesis. Università Politecnica delle Marche and Tallinn University of Technology, 2007, 171 pp.
- Van der Toorn J. and Mook, J.H., 1982. The influence of environmental factors and management on stands of *Phragmites australis*. I. Effects of burning, frost and insect damage on shoot density and shoot size. *J. Appl. Ecol.*, 19, 477–499.
- Weisner S.E.B. and Graneli, W., 1989. Influence of substrate conditions on the growth of *Phragmites australis* after a reduction in oxygen transport to belowground parts, *Aquat. Bot.*, 35, 71–80

6. Biogas Production from Reed

Veli-Matti Jalli, Livia College, Ülo Kask, TUT, Aigars Laizans, RTU

For production of biogas the fresh reed mass harvested in the summer suits better. The winter reed is too dry, and the reed does not contain enough of nutrients needed by the bacteria taking care of the methane digestion. Biogas is produced in digestion process which is an anaerobic decomposition process generating methane and carbon dioxide mainly. The excess sludge can be used as a fertilizer. Biogas can be used for both heat and electricity production as well as treated to bio methane as vehicle fuel.

Experiences using reed for biogas production as well as information on its yield are rather limited. Experimental study results from Tallinn University of Technology revealed that the biogas yield of summer reed is about 150 - 240 m³/t_{FM}. The methane content in biogas stays in the range 50-60% (Ü. Kask, unpublished). The calorific value of biogas is approximately 6 MWh/1000 m³. Jagadabhi et al. reported a methane yield of 220–260 m³/t of reed in laboratory-scale reactors. Laboratory experiments carried out in Kalmar municipality in Sweden also provided a methane yield of about 220 m³/t from co-digestion of reed (Risén et al.,) It has been estimated that the reed beds in Gotland, Öland and Kalmar municipalities in

Sweden could give up to 10 GWh of biogas energy from an available 5 670 tonnes of reed biomass.

Theoretical biogas yield of plant species is between 150 – 450 m³/t_{DM} and for comparison of pig slurry is 400 – 900m³/t_{DM} (Hagström et al., 2005).

In order to evaluate possibility to produce biogas from different reed, extensive research was provided in the Latvia University of Agriculture (V. Dubrovskis, 2011). First, element content was evaluated of winter and summer harvest of reed from Pape lake, Latvia (Table 6.1).

In order to evaluate gas output, two different combinations of reed were used – first research was done in the group of reactors (4 separate bioreactors with 5 litre volume), which were filled with chopped reed (cut size less than 20 mm) without add-ons, another research – with adding special chemical cellulase – ferment, which improves reed digestion and biogas production. Process temperature was kept 38±0,5 °C (mesophylic process for anaerobic digestion), pH was in the range 6,8-7,4, organic load 2,2-3,5 kg ODM/m³, HRT for reed with cut size up to 5 mm was 51 days, and HRT for reed with cut size above 10 mm was 80-90 days.

The results are presented in Table 6.2.

Table 6.1. Element content in dry and green reed, %_{DM}

| Main elements | Dry (winter) reed | Green (summer) reed |
|---------------|-------------------|---------------------|
| C,% | 46,2-47,3 | 46,9-47,2 |
| H,% | 5,4-5,5 | 5,87-6,38 |
| N,% | 0,36-0,42 | 0,64-1,21 |
| S,% | 0,04-0,08 | 0,07-0,28 |

The research revealed that biogas output from the reactors with ferment added increased by almost 2%, but H₂S content in the biogas increased almost for 8 times.

Research also revealed that the size has substantial impact on the output of biogas and CH₄ from dry (winter) reed – the smaller is the size, the larger is the output (Table 6.3), (Figure 6.1).

Table 6.2. Biogas output from bioreactors

| Combination of fill in | Biogas output, 50 days | CH ₄ % , average | CO ₂ % average | H ₂ S ppm average | CH ₄ , volume, l | Biogas output, l/g _{DOM} | CH ₄ output, l/g _{DOM} |
|---|------------------------|-----------------------------|---------------------------|------------------------------|-----------------------------|-----------------------------------|--|
| Green reed, cut size less than 20 mm, cattle slurry as fermentation starter | 24,55 | 51,1 | 46,4 | 28 | 12,53 | 0,294 | 0,150 |
| Green reed, cut size less than 20 mm, cattle slurry as fermentation starter, cellulase MTL (3,4g per reactor) | 24,91 | 51,1 | 44,8 | 235 | 13,03 | 0,298 | 0,156 |

Table 6.3. Biogas output from reed – cut size variation from 1mm up to 20 mm

| Cut size, average | Biogas output, average, l | CH ₄ % | CH ₄ , l | CH ₄ l/g _{ODM} |
|-------------------|---------------------------|-------------------|---------------------|------------------------------------|
| 1mm | 8,725 ±0,675 | 51,28±2,15 | 4,48±0,26 | 0,253 |
| 2mm | 6,96±1,48 | 53,38 ±5,6 | 3,7±0,76 | 0,208 |
| 5mm | 6,125±0,27 | 53,15±7,08 | 3,255±0,57 | 0,194 |
| 20mm | 5,083±0,91 | 49,34±0,77 | 2,511±0,49 | 0,141 |

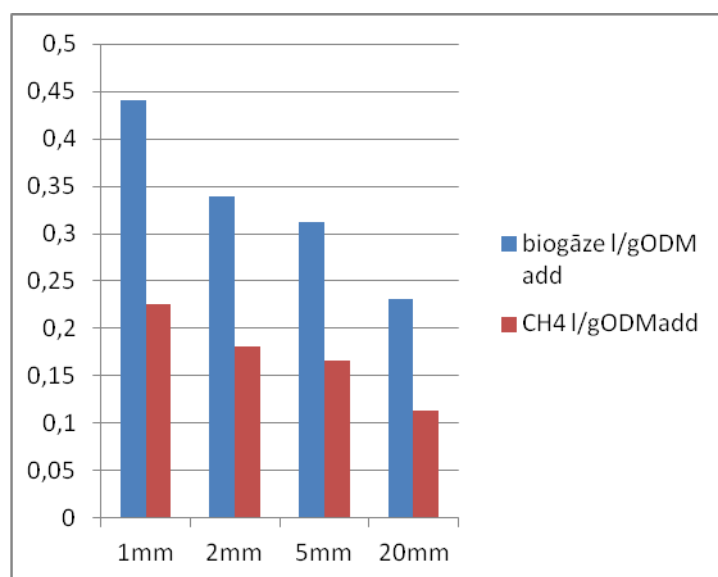

Figure 6.1. Average biogas and methane output, from winter reed, different cut sizes

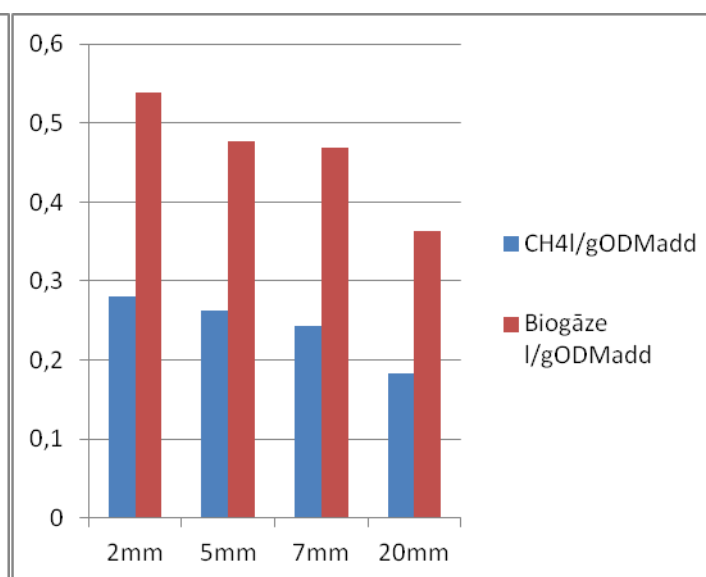

Figure 6.2. Average biogas and methane output from green reed, different cut sizes, l/g_{ODM}

Table 6.4. Biogas output from green reed

| Cut size, average | Biogas output, average, l | CH ₄ % | CH ₄ , l | CH ₄ l/g _{ODM} |
|-------------------|---------------------------|-------------------|---------------------|------------------------------------|
| 2 mm | 8,81 | 52,2 | 4,09 | 0,191 |
| 5 mm | 9,21 | 54,9 | 4,43 | 0,190 |
| 7 mm | 8,8 | - | 4,07 | 0,180 |
| 20mm | 7,13 | - | 3,16 | 0,152 |

It must be stressed, that the biodegradation ratio of reed is rather low, and during the biodegradation the bioreactor is being filled with lignin containing slowly biodegradable sludge. In order to increase this ratio co-fermentation is advisable by adding manure, wastewater sludge etc., increasing thus the nitrogen content.

The research results in the Latvia University of Agriculture showed that more methane can be extracted from green reeds – up to 280 m³ biogas from one ton of dry material (DM) (150 m³CH₄/t_{DM}), in comparison with 226 m³ biogas/t_{DM} (110 m³CH₄/t_{DM}) from dry reeds. (V.Dubrovskis, 2011)

The excess sludge from the biogas production can be used as an organic fertilizer. The sludge of reed harvested from 5 ha and used for biogas production would theoretically satisfy fertilisation requirements to up to 2–4 ha of farmland on an annual basis, assuming that about 60 % of the nitrogen and nearly 100 % of phosphorus in the reed biomass can be re-circulated. However, only summer reed can be used for producing biogas since the winter reed is too dry and its nutrient content is lower, which diminishes methane digestion by the bacteria (Iital, A. et al., 2012).

If biogas is to be produced from reed alone or a mixture of reed and other herbaceous plants, dry digestion would be the most appropriate technology. The end product of dry digestion (a digestion residue - digestate) is the same as that of wet digestion and it can also be used for compost making or as a fertilizer in the fields. The process reliability and stability should be considered as the benefits of dry digestion, neither foaming nor deposition occurs in the digester. At the same production volume the auxiliary energy demand is about 10% lower and the size of buildings and facilities in the biogas station is smaller.

The methane output will increase if the pig sludge and herbaceous biomass are digested together, because the most suitable carbon – nitrogen ratio (C/N) is formed. If the share of herbaceous mass is increased excessively, the yield of methane will decrease (Tuomisto, 2006).

It can be estimated that the hectare yield of harvested common reed in its energy content equals to the annual electricity demand of 1,5 - 2 in electrically heated small houses. Since there are more than 3 800 hectares of reed all in all in the province, it would be enough to guarantee the electricity and heating for 5 400 electrically heated small houses (Komulainen, M. et al., 2008).

The pilot area of Tuorla

The shore areas of Livia College have been seriously overtaken by reed during the last decades. Visual contact to Kuusistonsalmi strait – over the many meters high reed bed – has weakened and the strait itself has narrowed significantly when reed has occupied Tuorla's old coastal pastures and water areas (Figure 6.4). The aim during the project Cofreen (INTERREG IV A) has been to pilot the cutting of reed on Tuorla's shore areas and to utilize the reed biomass in energy production. Biogas production from reed and other biomasses has been a fundamental utilizing process. This has taken place in the biogas plant of Tuorla, which was completed in spring 2012 and is located only 300 meters from the shore where the reed material is cut. The total area of Tuorla's coastal areas' reed beds is approximately 20 hectares, from which approximately 8 hectares are on supporting land areas and the remaining 12 hectares on water areas.



Figure 6.3. The reed beds and the educational farm of Tuorla in summer 2013

Cutting of reed beds during the project

In 2011 the reed was harvested in two phases; the reed growing on land was crushed (by Lännen Järviperkaus Oy) and in water areas reed bed was mowed (by Telapari Oy) and reed was brought to shore for crushing (by Moto-Olli Oy). In 2011 the total harvesting area was the whole shoreline of Tuorla, i.e. 20 hectares. A part of the reed mass was stored into horizontal silos of then yet unfinished biogas plant and the rest was composted to be used for the soil improvement.

In the autumn of 2012 the reed growing in water areas was cut for the second time (by Telapari Oy), the mowing area of being 12 hectares. The harvest was small due to the successful harvesting in previous year. Concurrently, the reed biomass from

the cutting areas in Masku and Paimionlahti bay that were executed by Velho project were brought to Tuorla's biogas plant, crushed (by Moto-Olli Oy) and stored to horizontal silos together with Tuorla's reed biomass. The total amount of reed collected for the biogasification process was approximately 160 tons. In the early spring in 2013 the reed on Tuorla's land areas was cut, shredded and collected to the storage area on the shore (Lännen Järviperkaus Oy). As a result of the crushing in the autumn of 2011 and the extended pasturage of the calves in 2012, the yield was modest. The cut reed was tested in a chip burning plant of the size suitable for a farm (Jalli, Koski TI). However, the alteration in produced chaff length caused some technical problems during the combustion.

Impacts on the Tuorla's reed bed during the project

The use of coastal areas for recreation use and as the pasturage of calves has been improved by the cuttings. The vitality of the reed bed has been decreased by repetitive harvesting, and from last mowings the yield of reed biomass has been substantially more modest.



Figure 6.4. The reed bed of Tuorla before the cutting



Figure 6.5. The reed bed of Tuorla after cuttings

In 2012 new pasture fences were built on the shore areas and thus the usability of land-based reed beds in farming was improved. Cutting or crushing the overgrowing reed beds supports the availability of growing reed to the cattle for grazing.

Impacts on the birdlife in the area during the project

The report concerning birdlife and moor frogs living in reed beds and littoral meadow areas, and a schedule of work according to the reed bed strategy were extended to cover also the coastline of Tuorla (Klemola, 2011).

The work maps organized according to this report were considered when cutting. The Tuorla shore areas are not included in the Natura areas where the natural values should especially be taken into account. Based on the report, the Tuorla shore areas are suggested to be reconditioned into littoral meadows.

Klemola made a birdlife report as a follow-up to the rural institute's shores in May 2013. In conclusion it is noted that mowing of reed bed has brought bird species typical to a littoral meadow back to the area. The bird species resting in the area during their migration have shown diversification. On the other hand, the bird species typical to reed beds have suffered steep decline. The author of the report suggests that mowing and, if possible, even harrowing in the shore areas should be continued it.

The utilization of common reed for biogasification

In spring 2012 a farm scale biogas plant was completed at Tuorla. The plant uses left overs and materials from the agricultural activities of Livia college for gas production. The residues of anaerobic process as nutrients on the farm's fields are utilized. The sludge volume of both, the reactor and the secondary gas pool is 360 m³ and the gas storage volume is in total 440 m³. The main materials are swine slurry, dry manure of calves and different herbaceous biomasses. The biogas is utilized in local CHP for production of heat and electricity.

Perceptions of reed usage in the biogas plant

After mowing and before actual gasification, reed

had to be pre-treated, e.g. crushed and stored in horizontal silos to undergo the lactic acid fermentation. The purpose in biogasification is to follow as homogenous diet at the plant as possible. Because of this, it

has not been possible to drive a test period for one single material, when could have been estimated how much one ton of reed would product biogas. In addition, during the plant's first function year a lot of



Figure 6.6. The biogas plant at Livia College

work has been done for stabilizing the process, fixing the technical dysfunctions and to calibrate the online-measurements. The greatest problems have been related to biogas burning in the CHP. During the first winter season, two four-week test periods were driven through, focusing on controlling these functional factors mentioned above.

Over one year, approximately 160 tons of reeds have been used. Technically reed fermentation has functioned well. The crushing preparation before storage in horizontal silo has ensured the easiness of handling of the reed mass in grinding the dry matter, mixing and inputting to the reactor. Of the input masses, only reed chaff has been of optimal size concerning the particle size.

The production of biogas would bring even additional positive effects besides generated energy supply to the area. As a local energy source, it would

be one of the factors affecting the growth of a new kind of energy entrepreneurship, and thus having effect on the local employment and business. From the environmental point of view, the use of common reed would decrease greenhouse gas emissions, improve the quality of water and create a possibility to retrieve the nutrients dissolved in the waters back to the fields (Komulainen et al., 2008).

When the calculations are solely based on the gross energy price, the use of common reed is not practicable. But the same is valid for many other digested materials. According to (Riihimäki, 2006), the digestion of common reed needs an auxiliary pull from two directions. The first would be an energy subsidy for the common reed. The same energy plant subsidy should be allocated to the reed beds in energy use as to the fields in energy cultivation use. This would suffice to cover the costs of harvesting and would make the utilisation of the reed beds a real alternative.

Table 6.5. Amounts of biomass used for gas production during one year and yield of biogas utilized for bioenergy production

| Months, year | Feeding material | | | | | | | | Using bio-gas |
|--------------|------------------|----------------------|-----------------|---------------|----------------|---------------|--------------|-------------|----------------|
| | Silage | Leaves of sugar beet | Bales of silage | Reed | Pig slurry | Manure | Glycerol | Others | |
| | kg | kg | kg | kg | m ³ | kg | l | | m ³ |
| June 2012 | | | | 10000 | | | | | |
| July12 | 0 | 28050 | 2350 | 21700 | 30 | 1500 | 910 | 0 | 3489 |
| August12 | 1200 | 10180 | 7100 | 8300 | 137 | 26400 | 3860 | 0 | 4674 |
| September12 | 0 | 3100 | 14260 | 7220 | 74 | 23610 | 3300 | 1990 | 5769 |
| October12 | 38700 | 15000 | 11900 | 0 | 100 | 2800 | 1350 | 1000 | 5382 |
| November12 | 31200 | 26480 | 12993 | 0 | 122 | 0 | 1600 | 0 | 7897 |
| December12 | 13900 | 13650 | 6165 | 0 | 57 | 0 | 625 | 0 | 4303 |
| January 2013 | 31750 | 16800 | 14080 | 33500 | 74 | 0 | 975 | 1100 | 4283 |
| February13 | 46150 | 0 | 0 | 40100 | 75 | 0 | 675 | 0 | 4060 |
| March13 | 9300 | 0 | 12600 | 12700 | 81 | 56850 | 200 | 0 | 5862 |
| April13 | 3250 | 3400 | 12820 | 10100 | 76 | 51100 | 410 | 0 | 6396 |
| May13 | 5300 | 0 | 14210 | 18050 | 66 | 50870 | 1000 | 0 | 4238 |
| Total | 180750 | 116660 | 108478 | 161670 | 892 | 213130 | 14905 | 4090 | 56352 |

The production of biogas would bring even additional positive effects besides generated energy supply to the area. As a local energy source, it would be one of the factors affecting the growth of a new kind of energy entrepreneurship, and thus having effect on the local employment and business. From the environmental point of view, the use of common reed would decrease greenhouse gas emissions, improve the quality of water and create a possibility to retrieve the nutrients dissolved in the waters back to the fields (Komulainen et al., 2008).

When the calculations are solely based on the gross energy price, the use of common reed is not practicable. But the same is valid for many other digested materials. According to (Riihimäki, M. 2006), the digestion of common reed needs an auxiliary pull from two directions. The first would be an energy subsidy for the common reed. The same energy plant subsidy should be allocated to the reed beds in ener-

gy use as to the fields in energy cultivation use. This would suffice to cover the costs

of harvesting and would make the utilisation of the reed beds a real alternative.

References

- Dubrovskis, V. (2011) Papes ezera niedru kā izejvielu biogāzes ražošanai pielietošanas iespēju pētījums. (Pape lake reed as biogas production resource usage research). COFREEN research report Dubrovskis, V., Kazulis, V. Biogas production potential from various reeds. International conference on Renewable energies and Power Quality 28-30.03 2012 Santiago de Compostella RE&PQJ journal N10. P 515 CD. ISBN:978-84-615-6648-8

Dubrovskis, V., Koteļņecs, V, Zučika, A. Biogas producing potential from reeds. International conference Biogas world, Berlin 23-24.02.2012. CD.

Hagström, M., Vartiainen, E., Vanhanen J. 2005. Biokaasun maatilatuotannon kannattavuusselvitys. Loppuraportti, Gaia Group Oy.

Hatsala, A. 2004. Biokaasun tuotanto- ja käyttömahdollisuudet Kanta-Hämeessä. Hämeen ammattikorkeakoulu, ympäristötekniikan koulutusohjelma. Hämeenlinna.

Iital, A., Klõga, M., Kask, Ü., Voronova, V., Cahill, B. 2012: Reed harvesting. Compendium. An Assessment of Innovative and Sustainable Uses of Baltic Marine Resources. Maritime Institute in Gdansk, 2012. 103-123 pp.

Jagadabhi, P.S., Kaparaju, P., Rintala, J. 2011. Two-stage anaerobic digestion of tomato, cucumber, common reed and grass silage in leach-bed reactors and up-flow anaerobic sludge blanket reactors. *Bioresource Technology* 102, 4726–4733.

Riihimäki M. 2006. Vakka-Suomen Bioenergiastrategia. Vakka-Suomen seutukunta kuntayhtymä.

Rintala J., Lampinen A., Luostarinen S., Lehtomäki A. 2002. Biokaasusta uusiutuvaa energiaa maaseudulla. Jyväskylän yliopisto, Bio- ja ympäristötieteiden laitos.

Risén, E., Gregeby, E., Tatarchenko, O., Blidberg, E., Malmström, M.E., Welander, U. and Gröndahl, F. Assessment of bio methane production from maritime common reed. From an energy, greenhouse gas and nutrient balance perspective.

Tuomisto, H. 2007. Biokaasun ja peltoenergian tuotannon ja käytön ympäristövaikutukset. Maa- ja metsätalousministeriön työryhmämuistio 2006/1.



Reed panicle with seeds (Photo: Ü. Kask)

7. Reed as Handicraft Material

Satu Paananen, TUAS

Common reed has been utilised in numerous ways for centuries. In the pictography from 2800-2700 BC one has found that reed stalks were used as pens to write on the papyrus or damp clay. Therefore reed has played an important role in the development of mankind, writing and trade. It has been assumed that reed was used on the shores of the Gulf of Finland as early as in prehistoric times. The stalks might have been used to cover abodes or to make pipes and whistles, rhizomes might have been used as a food. Old writings from the late 18th century also reveal that in the 18th and 19th centuries stalks and panicles were used in crafts and construction, the rhizomes were used in folk medicine to treat many illnesses and complaints. (Häkkinen, J. 2007: 62-63.)



Figure 7.1. Fence made of common reed covers the view and protects well from the wind and sunlight. (Photo: A. Hemmi)

Common reed can and is used also nowadays in different kinds of crafts. Compared with the crop straw, reed is a more durable material, but also because of its stiffness and strength it cannot be used so well in plaiting crafts. Usually the reed used in construction is harvested in winter. However, for crafts the most durable and beautiful reed stalks can be got when harvested in summer and dried in the open air, for example on the slope of a roof.

When dry, reed can be peeled to become a clean and shiny straw.

Reed stalks protect very well from sunlight and reed chips can be used as protection against cold and that is why reed is an excellent material for protecting plant beds, for example.

Reed has traditionally been used in crafts in several ways. For example, musical instruments such as reed pipes, knitting needles, variety of mobiles, pot stands, sculptures, ecological green art pieces, mats, seat cushions and folding screens for many purposes have been made of it. (Lumo 2013) All the stalks, leaves and panicles can be used, and that plus reed's good insulation qualities make it a very versatile material.



Figure 7.2. Stalks of common reed used in a Christmas decoration made in 1920's. (Photo: E. Hagelberg)

To weave a reed mat, curtain, seat cover or screen, matting looms or rug looms can be used. It is fairly easy to put a matting loom together, for example from a wooden frame and hemp string. (Tuomela O. 2006: 12) Tightly woven reed stalks provide an excellent shelter and protection from the wind, sun and temperature variations. It keeps the fauna and flora, as well as their keepers safe.



Figure 7.3. A seat cover keeps you cosy and warm during cold times as well. (Photo: S. Lehti-Koivunen)



Figure 7.4. Reed can be used in many interior crafts, like this window decoration. Made by: Terhi Huuskonen from Kaarina (Photo: O. Tuomela)

Panicles have been used traditionally to stuff mattresses and cushions. For this purpose, reed is harvested after blooming, in the beginning of autumn, and then dried in the sun or in any other warm place, like sauna. The smoke of the sauna has also been used because of an effect, which destroys the microbes in panicles. Furthermore, it gives a fine and soft smoky smell to the pillow or mattress and conceals the smell of mud this way. For one cushion, about 3 kg of panicles is needed, for a mattress about 20 kg. Also the stalks can be used as stuffing material. It has been said that a well-made mattress can last for 10-15 years and with re-stuffing, up to 25-30 years (Häkkinen, J. 2007).

As a natural colorant for dyeing wool, reed is an excellent material. Stalks, leaves and panicles can be used for dyeing and they give a greenish or yellowish green colour. The best colorant is obtained when the leaves and stalks are harvested in the early summer before blooming. The reed fibre content makes it also suitable for making paper. For this use it is also the best when reed is harvested in summer when the fibre content is the highest.

For a bit more challenging craft, is to do ribbons from the dry stalks to be used in many kinds of plaiting crafts. A few centimetres long cut is made in soa-



Figure 7.5. Impressive shade for a table lamp made of ceramic pot, rice paper and reed stalks. Made by: Cornelius Colliander (Photo O. Tuomela)



Figure 7.6. Simple version of a rug loom makes it easy to weave a reed rug or a seat cushion (Photo: O. Tuomela)

ked wet stalk. From the cut the stalk is pulled open with a warm iron. With these ribbons one can weave

plates, which can be used as tablecloths, folding screens and sunshades, for example. (Lumo 2013)



Figure 7.7. Common reed works well as yellowish green colorant for wool (Photo: O.Tuomela)



Figure 7.8. Reed harvested in summer has the highest fibre content and it can be used for making light brown paper (made by Biopap Oy Fiskars) (Photo: O. Tuomela)



Figure 7.9. Sonic Seascape Terrace at Aurajoki river in Turku, Finland (Photo: O. Tuomela)

Common reed is a very good sound and heat insulator and because of these features the reed bales are an exceptionally good construction material. Within the ProNatMat project the “Sonic Seascape Terrace” in Turku was built from reed bales and clay in 2011. The underwater soundscape was created utilizing the sound insulating properties of reed and using underwater microphones. (Tuomela, O. 2007)

References

Häkkinen, J. Traditional use of reed 2007:62-72. Ikonen, I., Hagelberg, E. Read up on Reed, Vammalan Kirjanpaino OY

Lumo (05.06.2013). www.lumoverkosto.fi

Tuomela O. 2006. Ruoko ja muut röirit. Kuralan kylämäki. (05.06.2013) www.ruoko.fi

Tuomela, O., Decoster-Taivalkoski, M., Haastlahti, H. 2012: 22-27. The Story of the Sounding Reed Bales. Compendium of Promoting Natural Materials. Turku

8. *Business Models and Social-economic Effects of Reed Business*

Aigars Laizans, RTU

Opportunities of reed use

History of countries around the Baltic Sea shows that reed is not just plant with any use extensively growing in wetlands, lakes and seaside area. Reed was used for different purposes from ancient times – as a material for building purposes (starting with simple shelters, and up to basic material for walls and roofs/thatches), as a basis for weapons (for light arrows), and also for fun and entertainment (flutes, reed stalks dolls and masks, Christmas ornaments, etc.), and also in agriculture production (new sprouts for feeding cattle, stalks and straw – as litter, etc.). World experience shows samples of much wider reed usage – as a basis for paper – papyrus development in ancient Egypt, or as material even for ships – reed ships built from Titicaca lake reed, so there has to be a place for reed usage in modern economy as well.

Current applications of the reed include almost all mentioned above adding much wider usage of reed as renewable energy resource. Research shows that reed can be used for direct heat production (by burning), or indirectly – via biodegradation, biogas production and even cogeneration process in CHP, where both heat and electricity can be produced [Bain, et al. 2003]. At the same time the development of appropriate business model adjusted for local needs is needed, and this process is rather complicated and complex (Diltz, et al. 2011).

Evaluation of reed as the resource for business reveals that reed stalks in different forms can be used. Reed stalk without special processing (just cutting, pre-bundling for handling to the processing place, pre-cleaning, sorting and final bundling is necessary) is being used as ecologically excellent roofing material. Some additional processing (cleaning, sorting, cutting by length, bundling by size, putting in wall frames, etc.) is needed for the reed panels and plates production used in building walls and for insulation purposes. Production of reed blocks uses leftovers from reed cleaning and sorting – building blocks are produced by pressing the material.

Much serious processing is needed when reed biomass is being intended to use for heat production. Cutting in different sizes is needed for briquettes (larger parts – larger than 20 mm) and pellets (smaller than 20 mm) (Kronbergs, Smits, 2009). There is also experience to use reed stalks rolls and bales for direct burning, but some researchers stress on uneven burning regimes and problems with ash and exhaust gases, when such process is being used. Bales burning produced on average 7.5% ash which included about 2% points of unburned residues. Straw and stalks would have to be compressed and the boiler should be modified to improve airflow, completeness of combustion and handling of the large amount of ash formed (Morissette et al, 2011). At the same time other researchers stress on substantial cost reduction of bales and rolls burning – expensed decreased by 28-34% in comparison with coal burning (Zekic et al., 2010).

Reed usage for biogas production needs more efforts. Even timing when to cut the reed becomes important – as the research revealed, summer reed cutting and processing for later use for biogas production produces higher biogas output in comparison with winter reed (Dubrovskis, Kazulis, 2012).

Using reed for handicraft – for ornaments, carpets, hats, etc., needs very careful sorting, some special traditional processing and cutting. At most part this is being done using manual operations.

Business model

In order to reduce waste of time and money, and to increase the efficiency of business operations, the innovative business model should be developed. There are different definitions and structures of business model, but the most useful could be the definition mentioned by scientist and businessman A. Osterwalder: „Business model innovation is about new ways of creating, delivering and capturing value.” It can also be viewed as the collection of products and services a business offers to meet the needs of its

customers. Stewart and Zhao (2000) defined the business model as “a statement of how a firm will make money and sustain its profit stream over time.” Tavlaki and Loukis (2005) state, that Business model is a concept fundamental to business performance.

Business model structure includes four [Johnson, Christensen and Kagerman, 2010] to nine (Osterwalder, A., et al. 2010) parts. As the Business Model Canvas, offered by A. Osterwalder asks for much deeper localization and information about the particular area and company use, this approach will not be used in the current article, but it would be wise to use it if anyone decides to build business based on reed

as raw material in particular region. Approach used by M. Johnson and colleagues (Johnson, Christensen and Kagerman, 2010) will be presented here.

The main parts or components for business model building are as follows: there must be recognizable Customer Value proposition, Principles or formula of profit generation for the company/owner, Key resources needed, and Key process to be established and monitored.

The business model construction is presented in the Figure 8.1.

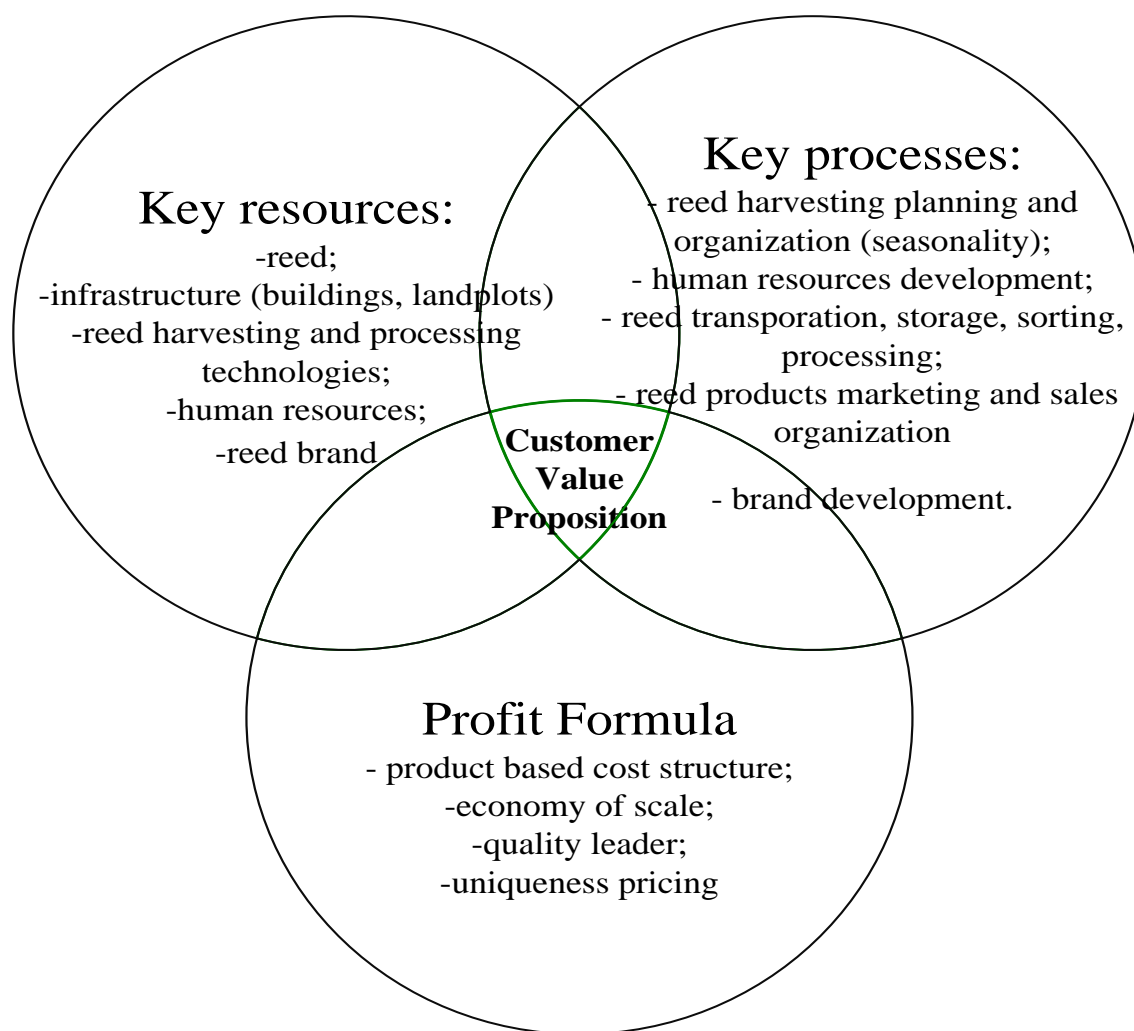

Figure 8.1. Unified business model for reed utilization

The Customer Value proposition (CVP) is the key issue for those who are evaluating the possibility to

enter reed products business. A company's value proposition is what distinguishes itself from its com-

petitors. The main result from CVP development should be the set of particular reed products properties, which are unique (globally or locally), with innovative attributes, which others can't copy easily, and with the customer needs satisfaction technologies which can't be substituted with the same qualities. The set will let the entrepreneur to build competitive advantage, and to be able to create the long-term plans and strategies.

The Key resource is reed as raw material – available and accessible in the lakes, wetlands, and seashore. The existing technologies of reed harvesting and processing – cutting, sorting, bundling, grinding, pelleting, handling and storing, and extensive facilities for reed storage and processing close to the reed cutting area, as well as people available and willing to be involved in reed business (both entrepreneurs and employees) are important key resources.

One Key resource - the brand of reed products developed from Baltic Sea region reed as extra value resource must be developed as the business people from Pape lake area, Latvia, have discovered that in the eyes of customers from Central and Western Europe the reed from this area have much better qualities as roofing material in comparison with reed from other areas in Europe – they stress that it has longer lifetime, and much proper dimensions (length, diameter). This, of course, should be recognized as substantial resource for CVP and particular brand building.

The Key processes required to launch, repeat and potentially increase in scale the reed business (excluding the common business company operations as accounting, etc.) are the following – reed harvesting planning and organization, taking in account rather strong seasonality, reed transportation, storage, sorting, processing and reed products marketing and sales organization.

One of very important key processes to be taken in consideration is high involvement of employees during the harvest season, and reduced need for workforce between the seasons. This is of particular importance in the regions where just winter harvesting is being applied because a lack of available workforce can happen if they are needed just 2-3 months a

year – they can be employed by the other businesses, where they have full year employment. Even farmers, who would be a bit more free during the late winter – early spring, are usually loaded with pre-season preparation, and only few could join the reed harvesting.

As to reed products sales and marketing – the brand name and brand value development is crucial, and export markets development to the regions with higher purchasing power and growing trends towards ecologically friendly fuel and building materials use is the key factor. Market development for reed products, stressing on the uniqueness of the products offered, can be a key factor (Matson, 2008).

Understanding of how the entrepreneur and company will generate profit from the reed business will attract more financial and human resources to the region and to the branch of the economy. Profit generation differs for different reed products.

For some reed products, the fact that they are handmade (national souvenirs, ornaments, etc.) can be the main part of customer value, and will be the reason for sale's margin increase, consequently. These products should be positioned as price/quality (design/art) leaders with the niche specification, where the buyers are well known, with uniqueness as the main driver.

The products which have more commodity characteristics (e.g., briquettes, pellets) will generate profit if the cost structure of production process will be comparable with the cost structure of substitute products and competitive products (wood pellets, stalks briquettes, etc.). Economy of Scale principle should be applied to these products, and specialization in one area can be the main principle for cost structure development.

The cost structure of reed for building purposes – for thatches, walls, etc., depends on the season, and also on the volume trades. Price (customer value) increase can take place if the special features like prolonged warranty, scientific proof of particular properties like fire resistance, strength, thermal conductivity, etc., can be provided to the end user.

Business model development for reed usage requires serious efforts and the involvement of all interested

parties – all stakeholders. Stakeholders are individuals or organizations with an interest in the success or failure of a project or entity.

Stakeholders involved are: External - government (state and municipal), shareholders - local and foreign investors (entrepreneurs), financing institutions – creditors, partners – suppliers, customers – users of

the product/service, and wide society; Internal – Owners of the business (entrepreneurs), Management, and Employees (Figure 8.2). Each of them has their own interests, values – direct and indirect, and the business model structure and tasks may change depending on their aims.

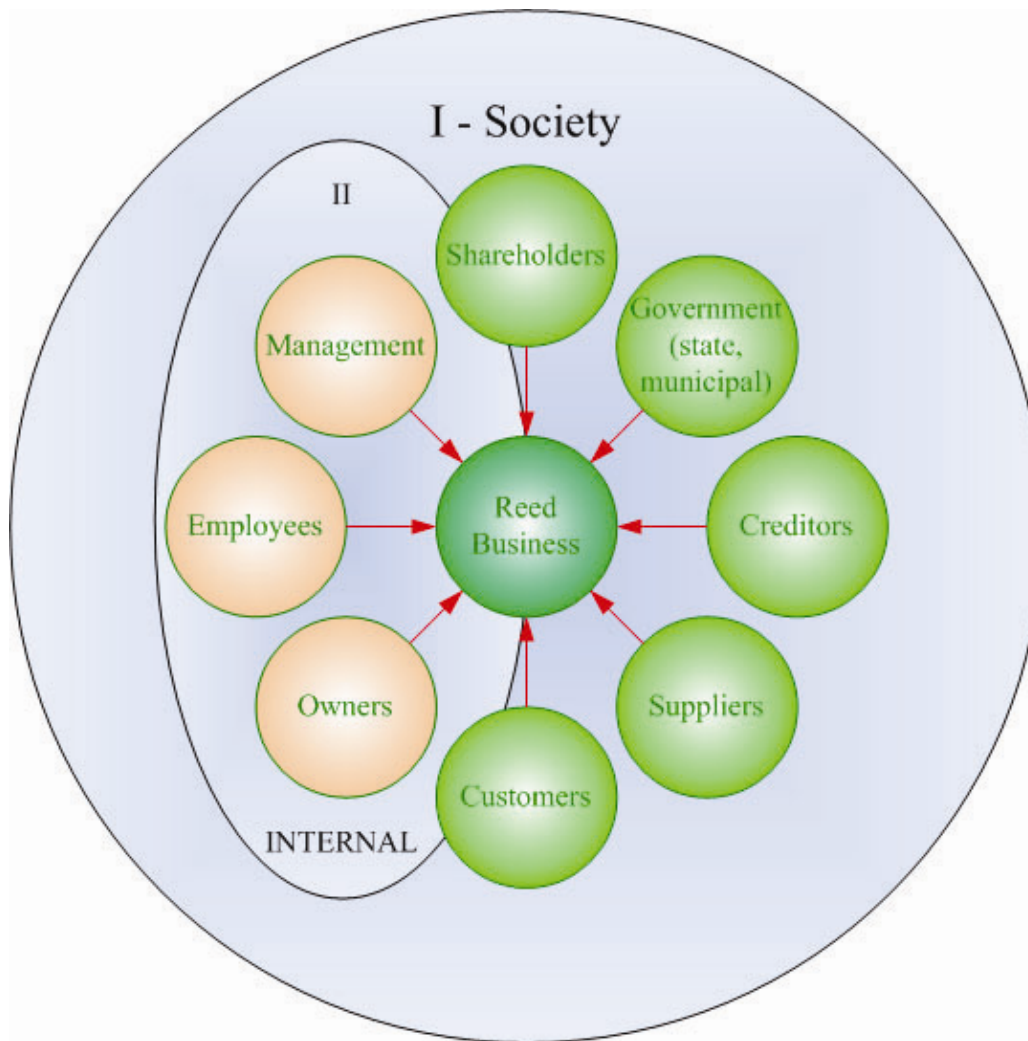

Figure 8.2. Stakeholders involved in reed business (I – external stakeholders, II – internal stakeholders)

In order to develop the business model, interests of all involved stakeholders in reed business should be evaluated.

The main interests of Government at the state and municipality level could be the following:

- Environmental issues – lakes and seashore cleaning from reed, and reed beds diminishing, especially in the areas where eutrophication process is too fast, and through reed expansion there is risk of environment problems.

- In order to improve ecology, the state must have incentives – as a good example could be mentioned the activity in Finland – they are evaluating possibility to subsidize the entrepreneurs who just cut reed, and thus clean the lands.
 - State support also can be through CO₂ emission quotas offer to the heat producers who utilize reed.
 - Excellent incentive to be provided by local municipalities can be switch towards biomass operated central heating systems development in local area, and local biomass usage through procurement tenders. Lower property tax, the size of which is the local municipality prerogative, can also be adjusted to initiate and boost reed based businesses.
- State budget increase through taxes and tariffs income from newly opened successful businesses – via company profit tax, via reed areas usage fees (Latvia case – State Environment Agency started to make reed bed area usage auctions and from 2012 is receiving annual payments from the reed harvesters for allowances to work on Pape lake), indirectly – via salaries and wages paid to employees;
 - Overall employment – reduction of local (geographical, structural) unemployment – reduced stress on social budget, lowered social stress, happier citizens;
 - Regional (countryside) population development opposite to people movement to large urban regions – reduced stress on urban infrastructure – roads, utilities, more equalized spread of population over the state territory, reduced pollution.

The Creditors, Suppliers, Shareholders, and Customers want to receive stable product/service/payment/income flow from the reed business, keeping their values at high level. Creditors – financing body, want low risk investment which can cover short- and long term liabilities, Shareholders want stable and high income flow (share price increase) and long-term perspectives.

Suppliers must take in account seasonality of the business, and niche products specification, thus there

can be need for specialized individualized equipment and instruments requested by reed harvesting and processing entrepreneurs.

As the scope of products from reed as a raw material is rather large, the Customer scope will also be mixed, with different values. This can be challenging for the entrepreneurs – they must keep customer focus, and find adequate and sufficient number of customers in order to have economically viable volumes of reed products sales.

As the reed business has strong seasonality (due to very short harvesting time in winter, and strong limitations on harvesting during summer due to environmental protection limits – birds nesting and fish spawning) reed harvester from Latvia experience in year 2012/13 season showed that due to particular weather conditions during this winter they have to do all harvesting during one month – March 2013), particular attitude must be taken to human resources management in reed business. If it is allowed or if there are supported activities to clean reed beds also during summer time, using floating movers, then the season could be prolonged. Financial resources and demand for environment protection are scares in Latvia and Estonia, some resources are available for reed cutting in Finland, but the entrepreneur must take into account travelling and equipment transportation expenses, as well as the increase in employment costs (travelling, per diem allowances, etc.). Company management must have to develop the operations plan which keeps basic employees connected with the company for whole year, and possibility to hire more employees during the high load period. (Entrepreneur working on Pape lake, Latvia, has around 30 employees during high season, and in average 10 employees on annual basis. His annual sales volume is around 100,000 EUR, and all production is being exported to the Western Europe, with very limited local sales (close to 20,000 EUR)). In order to be sure that there will be necessary staff to be hired during high seasons, managers and owners of the company must create loyalty packages for key employees, and use differentiation, introducing as many as possible products produced from reed.

Raw material storage after harvesting with later processing during the whole year can also be considered as a reducer of employment risks. Of course, the economic analysis must be provided to calculate storing and handling expenses and appropriate premises and land availability. As the areas with reed are usually located in the remote areas, the land sales and rent prices are rather low, and they are available for reed storage. This is very good if there are appropriate buildings where reed can be stored and processed. This is a case of Pape lake area, where some unused buildings were rented by the entrepreneur from the local municipality for reed business.

Some of the business models which arise from reed area research are the following:

- Reed pellets production, which includes the following steps – reed harvesting (moving) in winter, handling to the chopping area, further chopping, pelletizing, pellet storage, and delivery to heat producers and shops for private users. As research made in Latvia stated, the best pelleting conditions – the lowest energy consumption of production with optimal strength of pellets, adequate ash and exhaust gases combination, and overall cost, is for reed/peat mixture containing 70% reed and 30% peat. This model could be used in the places where appropriate peat lands are close by the reed beds. One important drawback of reed and potentially other straw material pellets burning is the increased corrosion of burners, and substantially larger ash content (Hansen, 2000; Alipour, 2013; Riedl et al., 1999; Bryers, 1996).
- Chopped reed usage in furnaces together with other biomass. This model includes the following steps – reed harvesting (moving) in winter, handling to the chopping area, further chopping, transferring to the burning agent for mixing with other chopped biomass – woodchips, stalks, etc. (Bain, Overend, & Craig, (1998). The model described can be used by several medium size heating operators – the most advanced complex burning systems in the project area belong to the biggest heat producing company – Fortum Ltd, Finland, which built such stations in Pärnu and Tartu, Estonia, and Jelgava, Latvia, as well as several similar plants in Finland.
- Baled reed stalks direct burning – common in large scale boiler houses, which requires less op-

erations – just moving the reed in winter, instant baling, handling to the bales storage premises, and further delivery to the boiler house. This application has serious drawbacks as to burning qualities – research show lower efficiency, problems with ash melting, and signs of dioxins in the exhaust gases, at the same time it is amongst the less costly models (Morissette, Savoie, and Villeneuve, 2011).

- Reed bed removal (including moving and harvesting) for environmental reasons – can be done both in winter time (reducing dry matter on the lands and water) and in summer time, when green growing reed is being cut. The expenses of operations will be covered from state support for environment conservation and restoration funds, as well as from EU subsidies for the same activities. This model needs the political decision from EU and Baltic states to include reed bed removal in subsidized activities list.
- Reed usage in cogeneration plants via biogas production, and further heat and electricity production, taking in account processed biomass as excellent fertilizer. This model is technically and technologically the most complex and complicated, and asks for the largest investments and coordination between different stakeholders.
- Reed usage as building material (for walls and thatches) – the product with high added value, but for rather small niche customers. This model includes the following steps – reed harvesting (moving) in winter, handling to the storage place (if the harvester does not provide instant bundling), sorting, cleaning and re-bundling (manual), bundle storage, delivery to the construction place.
- Reed usage for souvenirs, traditional ornaments – very small, local, tourists oriented entrepreneurial activity. Requires knowledge of reed historical applications, national traditions, and handcrafting skills. Reed consumption for this activity is minor, but creates local social and economic values for society.

In order to develop stable and long-lasting business, the business models may have several different shapes.

For producer organization model, the cooperatives of reed as raw material using companies can provide the members with additional economic benefits like synergy – fuller usage of raw material, lower costs of co-working, shared expenses of entering new markets, potential to generate larger sales volumes, and joint opinion development in the discussions with state and municipal officials as to reed-based business future. Marketing activities can also be more efficient, and joint brand name can be developed, stressing particularities of the products, and creating larger awareness amongst customers. The drawback of this model is the difficulty to organize the co-operatives for independence-loving entrepreneurs, and their willingness to be open and co-operative with other partners.

There also can be buyer driven models, where larger buyer, like Fortum Ltd, Finland, states the rules and principles of reed pellets and other burning materials production and delivery. This could allow also small suppliers to participate in deliveries, although the purchasing power then is in hands of the end-user.

The intermediary model which implies the intermediary organization as communicator between small producers and numerous medium and large consumers can be applied also. This model allows producers to keep their individuality and separateness, at the same time allowing them to sell all amounts to serious consumers.

The SWOT (Strengths-Weaknesses-Opportunities-Threats) analysis of reed use shows the following:

- Internal Strengths:
 - Reed is renewable resource, with intensive growth, which is consuming CO₂ and excess fertilizers from soil and water (nitrogen, phosphorus) from the surrounding environment, so diminishing climate warming and greenhouse effect;
 - Raw material (reed stalks, biomass) production costs are minimal – no expenses for growing and nurturing;
 - Reed as a natural building material is environmentally friendly, durable and sustainable;
 - Reed applications have extensive history in Baltic Sea countries, it is well known also in

surrounding area, also extensive scientific research was done and are available publically during last decades to understand its application fields;

- In the eyes of current reed products buyers - customers the reed from Baltic Sea area has higher building qualities, it can have better sales qualities;
- Reed can be used for heat production in different forms, including even biogas production;
- Reed grows in the remote areas, where labour costs are lower, so overall costs are low, and allowing establishing good profit margin.
- Internal Weaknesses:
 - Reed harvesting is directly connected with the areas where special environment protection regulations are imposed – time, chemical and acoustical pollution, proximity to the live beings restrictions may occur during the year;
 - Reed harvesting for building and heat production purposes has very short season, especially for winter reed – only 1..2 months within a year are acceptable for serious technological harvesting;
 - Reed processing and reed products production chains are underdeveloped, with several links like storing, sorting, chopping, etc., technologies having weak development. Reed products burning needs deeper research and innovative solutions in order to increase process efficiency and by-products security and safety;
 - Human resources (employees) quality and availability in the remote areas where the reed beds are located, in some areas is insufficient, and seasonality of the process makes it difficult for harvesting and processing organization.
- External Opportunities:
 - Reed usage for heating and electrical energy production locally, and within EU can reduce dependence of the imported fossil fuels, and create jobs for people in remote areas;
 - Reed as environmentally friendly building material becomes more and more used for the individual houses – it can compete with other

artificially made roofing and insulation materials both from technological and cost reduction points of view;

- External Threats:
 - Public opinion of reed as a weed or waste is dominating, limiting the reed products use;
 - Other substitutes with also low production costs, like straw or hay, but with more positive aptitude from public decision makers damage the reed market;
 - Reed, as a building material, producers – usually small companies, are competing with large industrial building materials producers – the fight is unequal due to different marketing and promotion budgets.

Overcoming the problems mentioned in the SWOT analysis, and building appropriate business model, which includes also signs of cooperation can boost the reed usage, and considerable social-economic impact can be recognized in a form of taxes, employment rates, imports reduction and exports increase on state, municipality, and local community level, especially if all Baltic Sea region countries will recognize reed as valuable source and take serious and joined efforts towards its use.

References

Alipour Y., (2013) High temperature corrosion in a biomass-fired power boiler. Licentiate Thesis in Corrosion Science, Stockholm, Sweden 2013 Available at:
<http://kth.diva.portal.org/smash/get/diva2:617187/FULLTEXT01.pdf>

Amon, T., Amon, B., Kryvoruchko, V., Machmüller, A., Hopfner-Sixt, K., Bodiroza, V., Hrbek, R., Friedel, J., Pötsch, E., Wagentristl, H., Schreiner, M., Zollitsch, W. (2007) Methane production through anaerobic digestion of various energy crops grown in sustainable crop rotations Bioresource technologies, 98, 3204-3212.

Bain, R. L.; Amos, W. P.; Downing, M.; Perlack, R. L. (2003). *Biopower Technical Assessment: State of the Industry and the Technology*. Report No.

NREL/TP-510-33123. Golden, CO: National Renewable Energy Laboratory,
http://www.fs.fed.us/ccrc/topics/urban-forests/docs/Biopower_Assessment.pdf

Bain, R. L.; Amos, W. P.; Downing, M.; Perlack, R. L. (2003). *Highlights of Biopower Technical Assessment: State of the Industry and the Technology*. Report No. NREL/TP-510-33502. Golden, CO: National Renewable Energy Laboratory.
<http://www.nrel.gov/docs/fy03osti/33502.pdf>

Bain, R. L.; Overend, R. P.; Craig, K. R. (1998). *Biomass-Fired Power Generation*. *Fuel Processing Technology* (54); pp. 1-16.

Bryers, R. (1996) Fireside slagging, fouling and high temperature corrosion of heat transfer surfaces due to impurities in steam raising fuels. *Follow Progress in Energy and Combustion Science*, Volume 22 (1) pp 29-120, Elsevier – Jan 1, 1996.

Business Model Generation, A. Osterwalder, Yves Pigneur, Alan Smith, and 470 practitioners from 45 countries. Self published, 2010.

Business Model: a prerequisite for success in the network economy, Elena Tavlaki, Euripides Loukis. (2005) Bled, Slovenia. Available in:
[https://domino.fov.uni-mb.si/proceedings.nsf/0/9464c536b63d0f8fc1257014004a3b48/\\$FILE/30Tavlaki.pdf](https://domino.fov.uni-mb.si/proceedings.nsf/0/9464c536b63d0f8fc1257014004a3b48/$FILE/30Tavlaki.pdf)

Converting Waste Agricultural Biomass into a Resource – UNEP (2003), available in :
<http://www.unep.org/ietc/Portals/136/Publications/Waste%20Management/WasteAgriculturalBiomassESTCompendium.pdf>

Diltz, R.A., Luckarift H.R., and Johnson, G.R. (2011) Sustainable Land Use for Bioenergy in the 21st Century. *Industrial Biotechnology*. December 2011, 7(6): 437-447

Dubrovskis, V., Kazulis, V. (2012). Biogas production potential from reeds. *Proceedings of International Conference on Renewable Energies and Power Quality (ICRE PQ'12)* Santiago de Compostela

(Spain), 28th to 30th March, 2012.
http://www.drfn.info/docs/reeds/Biogas_production_from_REEDS.pdf

Feasibility of Improving Biomass Combustion through Extraction of Nutrients (2011). Available at: <http://www.ofa.on.ca/uploads/userfiles/files/cennatek%20ofa%20report-feasibility%20of%20improving%20biomass%20combustion%20through%20extraction%20of%20nutrients.pdf>

Hansen, L.A., Nielsen, H.P., Frandsen, F.J., Dam-Johansen, K., Horlyck, S. & Karlsson, A.(2000) Influence of deposit formation on corrosion at a straw-fired boiler. *Fuel Processing Technology*, Volume 64, Number 1, May 2000 , pp. 189-209(21)

Hansson, P-A. & Fredriksson, H. (2004): Use of summer harvested common reed (*Phragmites australis*) as nutrient source for organic crop production in Sweden. *Agriculture, Ecosystems & Environment* 102, 365-375.

Internet marketing, business models and public policy. Stewart D. W., Zhao Q., (2000). *Journal of Public Policy and Marketing*, Vol. 19 (Fall), pp. 287-296.

Kronbergs, E., Smits, M. (2009) Cutting properties of common reed biomass. Proc. of 8th International Scientific Conference „Engineering for rural development”, Jelgava, Latvia, 28-29 May, 2009, publ. LUA, pp. 207-211

Mason, Katy J. (2008) Markets, business models and growth of the firm. In: *The 24th IMP Conference Studies on Business Interaction – Consequences for Business in Theory and Business in Practices*, Thurs-

day 4th September – Saturday 6th September 2008, Uppsala University. Available in: <http://impgroup.org/uploads/papers/6328.pdf>

Morissette, R., Savoie, P., and Villeneuve, J. (2011) Combustion of Corn Stover Bales in a Small 146-kW Boiler. *Energies* (19961073). Jul2011, Vol. 4 Issue 7, p1102-1111. 10p.

Reinventing Your Business Model, by Mark W.Johnson, Clayton M.Christensen, and Henning Kagermann, Harvard Business Review, 2008. http://www.ondernemenzondergrenzen.nl/uploaded_files/6_reinventing_your_business_model.pdf

Riedl, R., Dahl, J., Obernberger, I., and Narodoslawsky, M. (1999) Corrosion in fire tube boilers of biomass combustion plants, Proceedings of the China International Corrosion Control Conference, Beijing, China.

Timmermann, T. (2003). Nutzungsmöglichkeiten der Röhrichte und Riede nährstoffreicher Moore Mecklenburg-Vorpommerns. *Greifswalder Geographische Arbeiten* 31: 31 - 42.

Wichtmann, W., & Joosten,H. (2007) Paludiculture: peat formation and renewable resources from rewetted peatlands. <http://www.imcg.net/pages/publications/newsletter.php?lang=EN>, <http://www.imcg.net/media/newsletter/nl0703.pdf>

Zekic V, Rodic V, Jovanovic M. (2010) Potentials and economic viability of small grain residue use as a source of energy in Serbia. *Biomass Bioenergy*, Dec 2010, Vol. 34 Issue 12, p 1789-1795:7



Modern dwelling houses with thatched roofs in Amacems in Latvia (Photos: J. Miljan)



INTERREG VI A PROJECT PARTNERS AT LAKE PAPE IN LATVIA (Photo: A. Zucika)



TALLINN UNIVERSITY OF
TECHNOLOGY



www.emu.ee
Eesti Maaülikool
Estonian University of Life Sciences



Elinkeino-, liikenne- ja
ympäristökeskus



RIGA TECHNICAL UNIVERSITY